

	9	10	11	12	13
H min	1980mm	2200mm	2420mm	2640mm	2860mm
H max	2142mm	2380mm </td <td>2618mm</td> <td>2856mm</td> <td>3094mm</td>	2618mm	2856mm	3094mm
DM120	232°	258°	284°	310°	336°
DM140	236°	262°	288°	314°	340°
DM160	205°	228°	251°	273°	296°

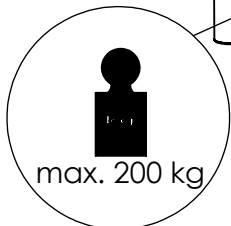

DM 120

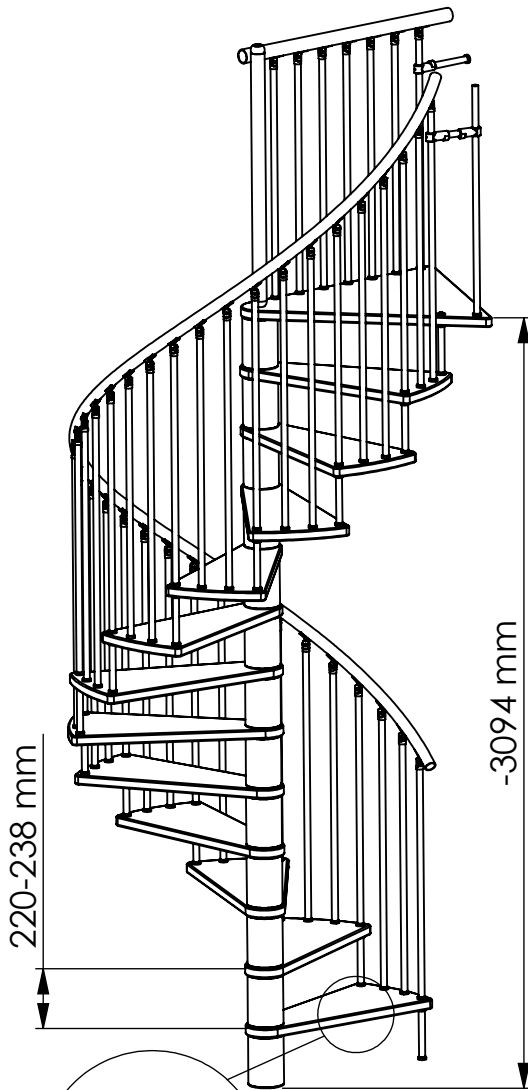

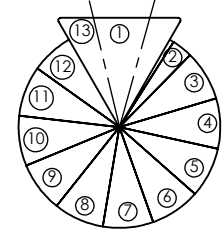
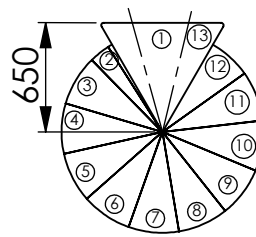

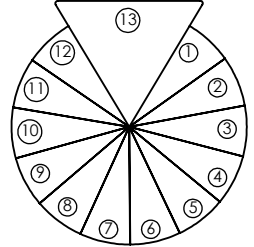
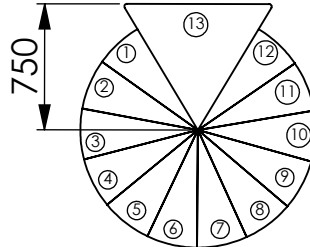



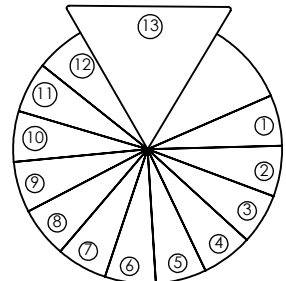
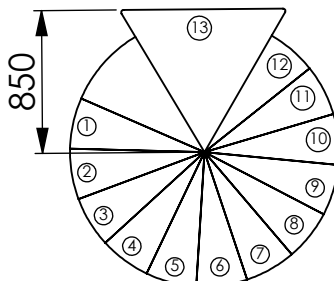



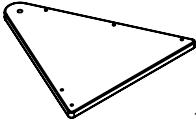
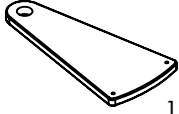
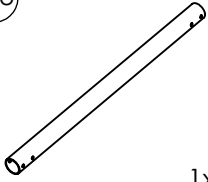

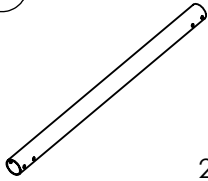
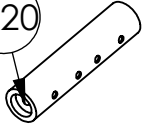
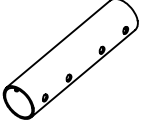
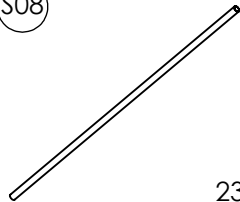
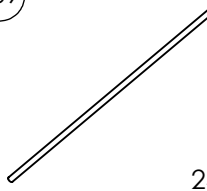
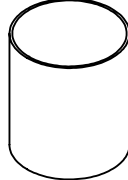

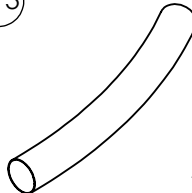
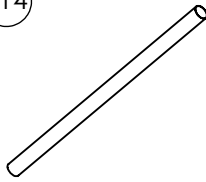
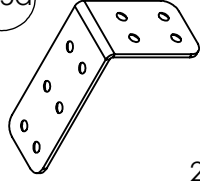
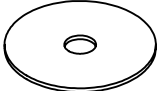
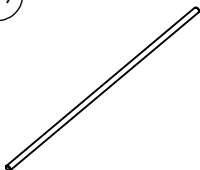
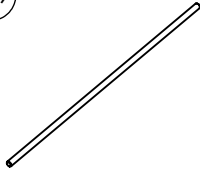
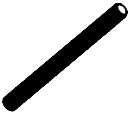
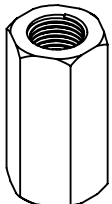
DM 140

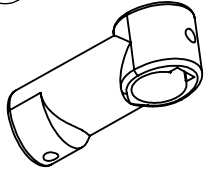
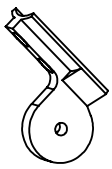

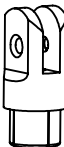









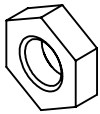

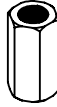

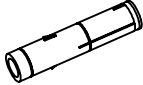
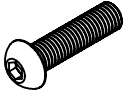
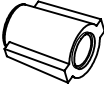
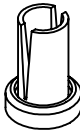
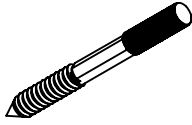
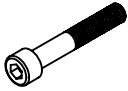
DM 160

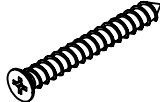

Spiral decor/effect, EB-2009-07

S01  1x	S02  12x	S03  1x Ø 50 x 910x1 mm	S04a  1x Ø 51 x 100 mm	S05  2x Ø 60,2 x 980 mm
S06  1x Ø 51x2,6x220 mm	S07  1x Ø 51x2,6x220 mm	S08  23x Ø 22x1x840 mm	S09  24x Ø 22x1x1100 mm	S10  13x Ø 127x179 mm
S11  14x Ø 22x1x175 mm	S12  1x Ø 22x1x70 mm	S13  12x Ø 50x1x400 mm	S14  1x Ø 50x1x952 mm	S15a  2x
S16  1x Ø 100 x 3 mm	S17  2x M20 x 1000 mm	S19  6x M8 x 1000 mm	S20  1x M10 x 120 mm	S21  1x M20 DIN 6334
S22  104x Ø 127 x 3 mm	S23  3x	S24  46x	S25  17x Ø 50 mm	S26  46x
S27a  12x Ø 8 mm	S27b  2x Ø 12 mm	S28  1x Ø 22 mm	S29  5x Ø 35 mm	S30  1x M20 DIN 934

Spiral decor/effect, EB-2009-07

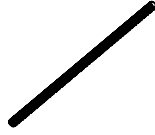
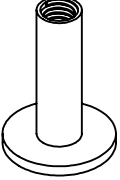
<p>S30a</p>  <p>M20 DIN 439B 1x</p>	<p>S31</p>  <p>M8 DIN 434 11x</p>	<p>S32</p>  <p>M5 DIN 934 46x</p>	<p>S33</p>  <p>M8 DIN 6334 4x</p>	<p>S34</p>  <p>M6 DIN 562 6x</p>
<p>S35</p>  <p>M8 x 55 mm 4x</p>	<p>S36</p>  <p>M10 x 70 mm 34x</p>	<p>S37</p>  <p>M10 50x</p>	<p>S38</p>  <p>74x</p>	<p>S39</p>  <p>M10 x 100 mm 2x</p>
<p>S40a</p>  <p>M8 x 50 mm 4x</p>	<p>S41</p>  <p>M8x55mm DIN6912 8x</p>	<p>S42</p>  <p>M5 x 20 mm DIN7991 46x</p>	<p>S43</p>  <p>M6 x 6 mm DIN 914 6x</p>	<p>S44</p>  <p>Ø 6 x 50 mm 12x</p>
<p>S45</p>  <p>Ø 6 x 30 mm 8x</p>	<p>S46</p>  <p>Ø 3,9 x 16 mm 92x</p>	<p>S47</p>  <p>Ø 30 x 3 mm 124x</p>	<p>S49</p>  <p>8x</p>	<p>S50</p>  <p>M8 x 14 mm 1x</p>
<p>S51</p>  <p>Ø 4 x 25 mm 46x</p>	<p>S52</p>  <p>M10 x 300 mm 12x</p>	<p>S53</p>  <p>12x</p>		

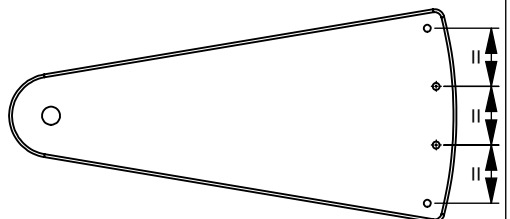
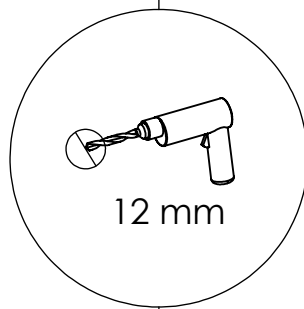
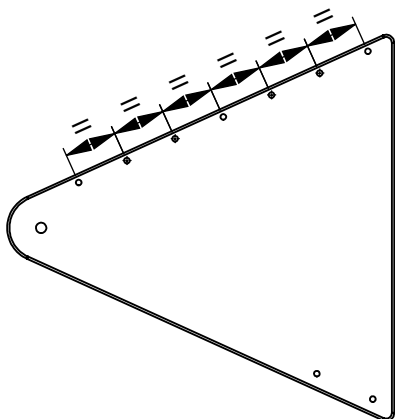

h	
0xS47	= 220 mm
1xS47	= 223 mm
2xS47	= 226 mm
3xS47	= 229 mm
4xS47	= 232 mm
5xS47	= 235 mm
6xS47	= 238 mm

h	
2xS22	= 220 mm
3xS22	= 223 mm
4xS22	= 226 mm
5xS22	= 229 mm
6xS22	= 232 mm
7xS22	= 235 mm
8xS22	= 238 mm

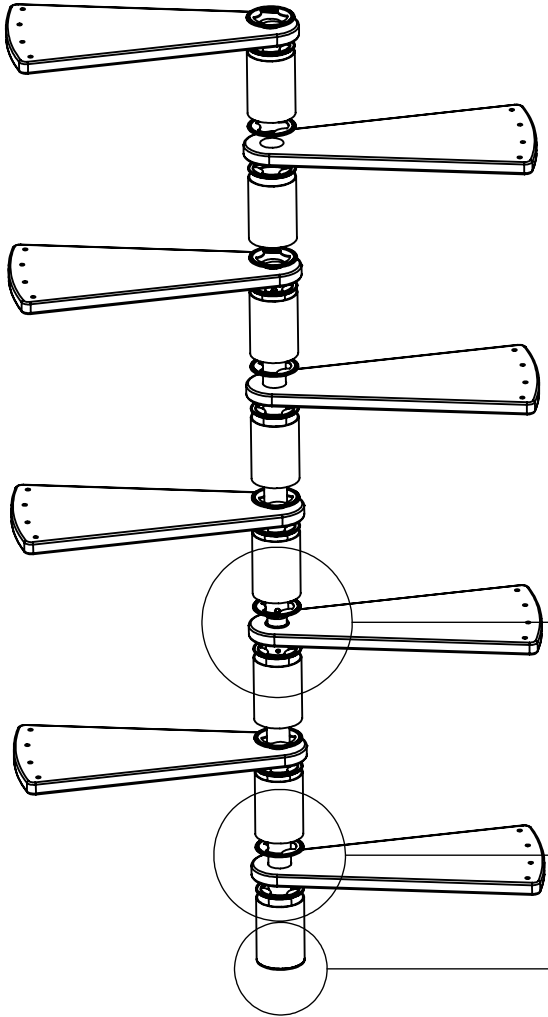
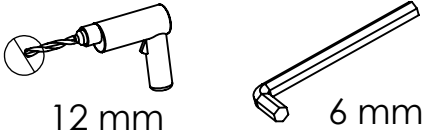

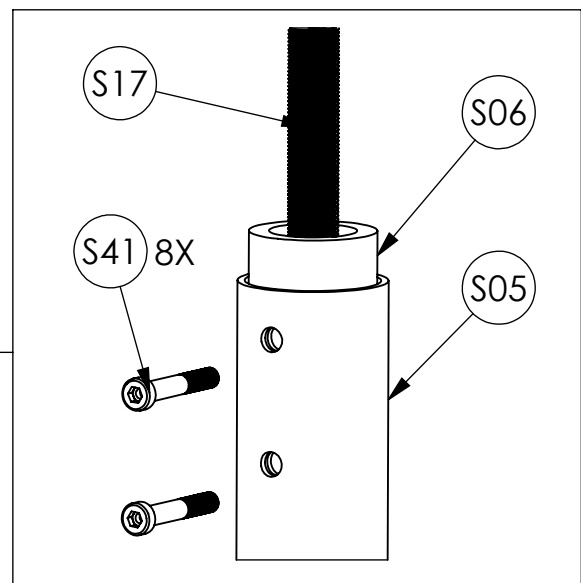
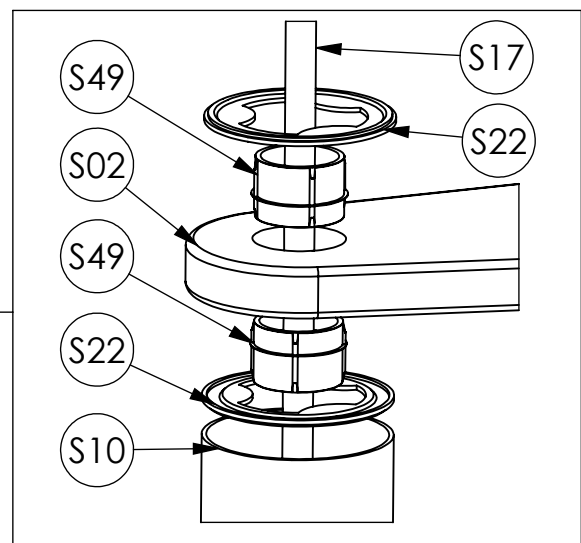
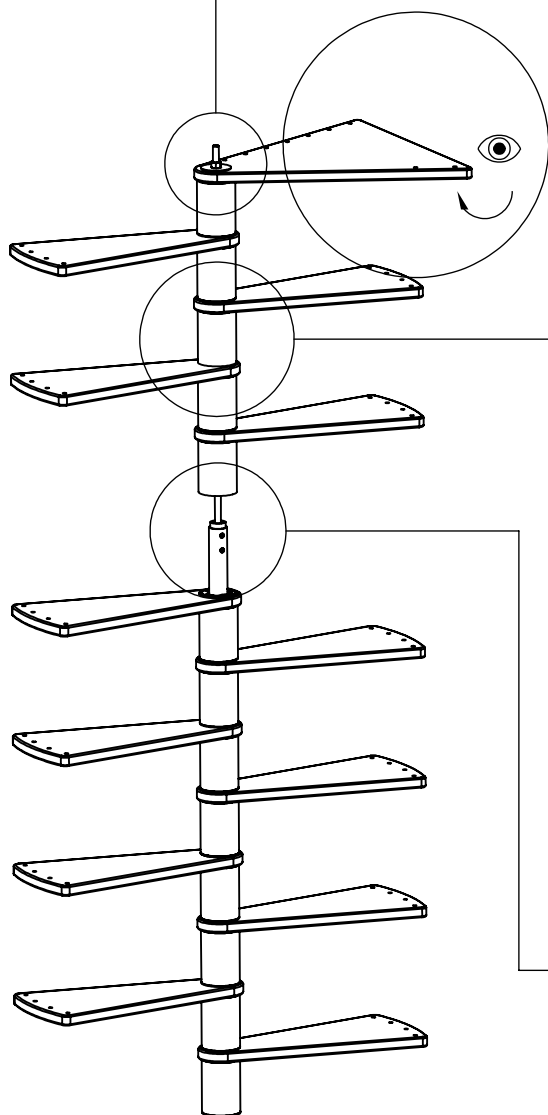
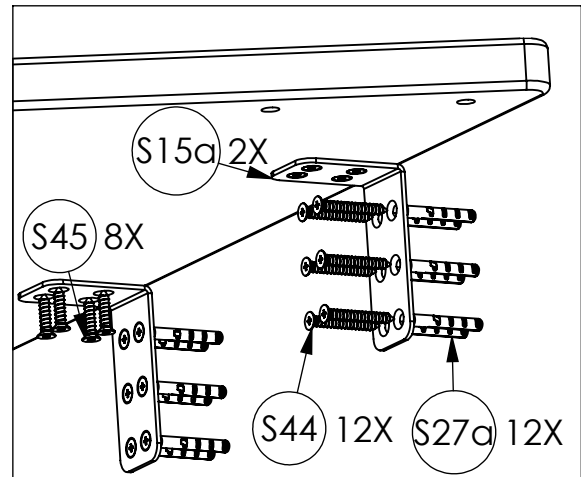
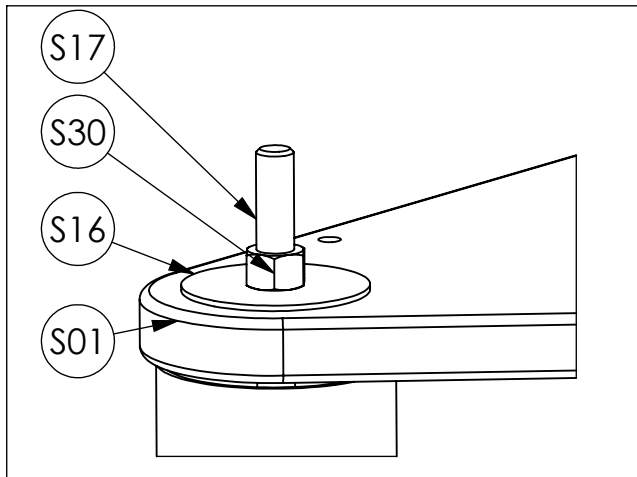
5



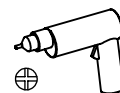
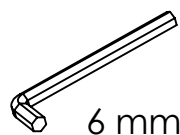
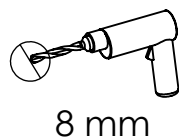
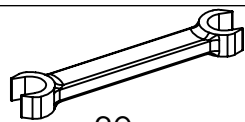

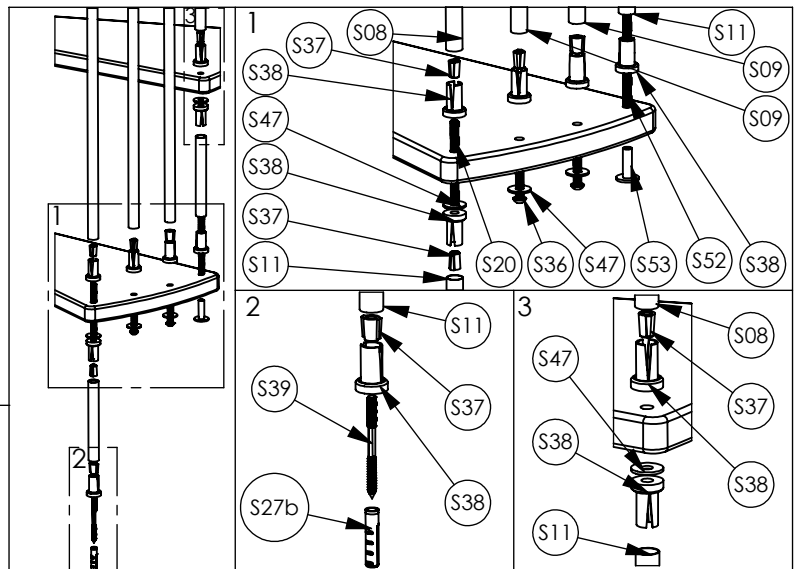
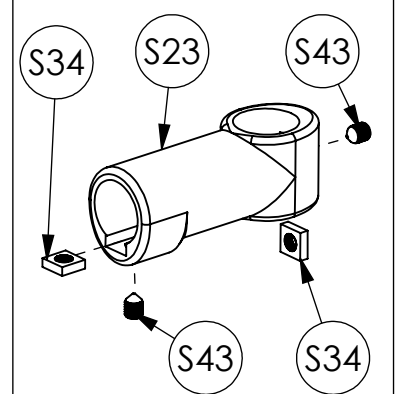
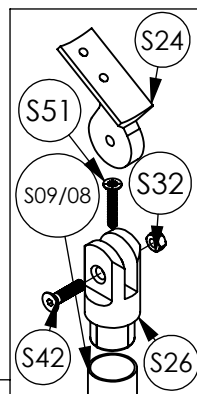
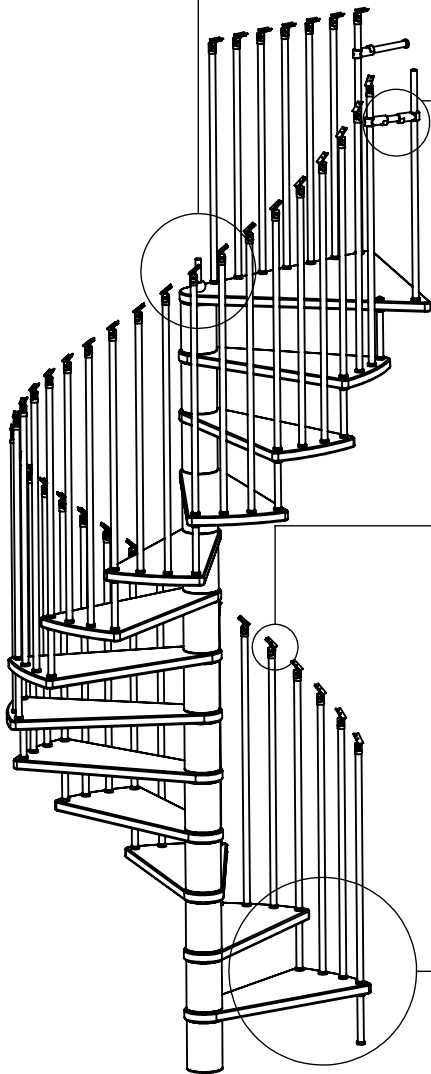
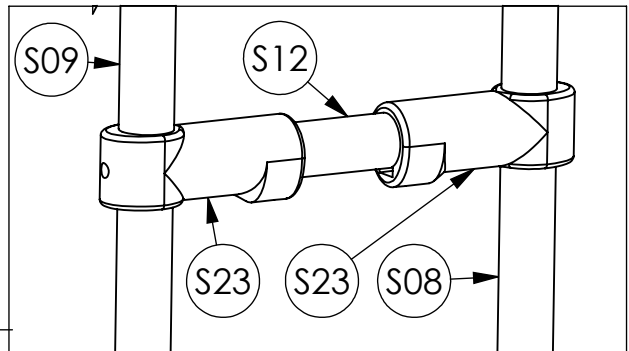
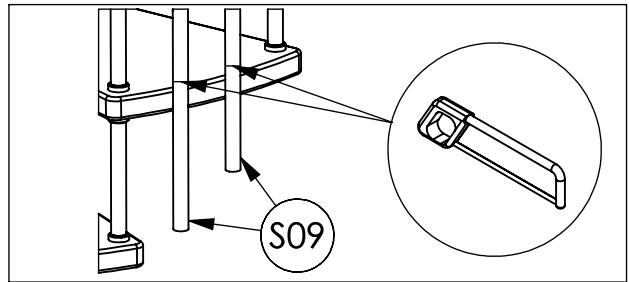
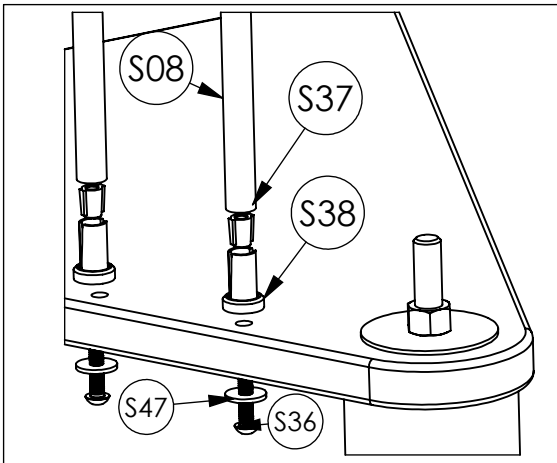
6

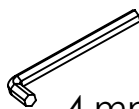

4 mm



3 mm



8 mm

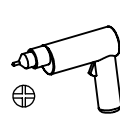

12 mm

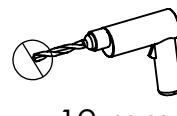

8 mm

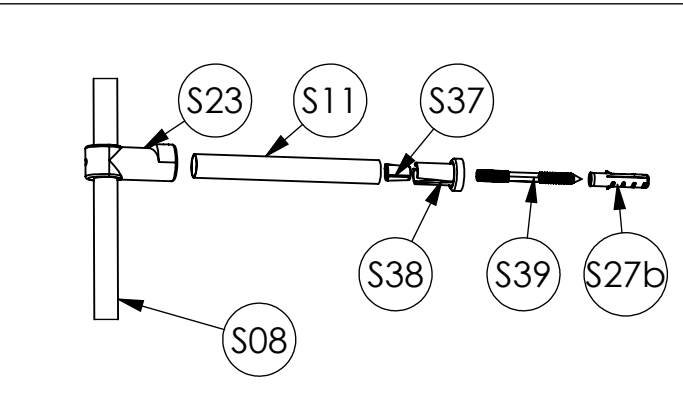
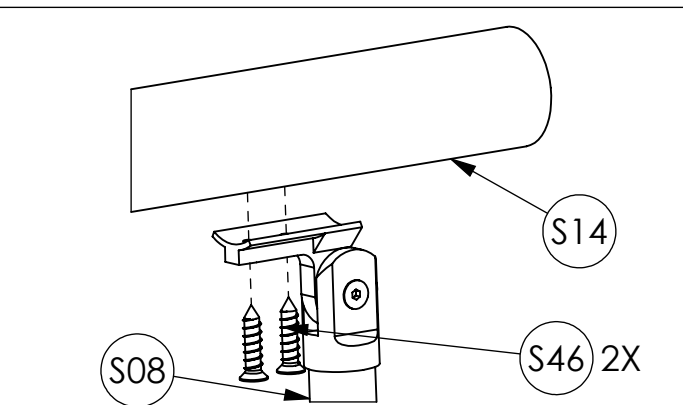
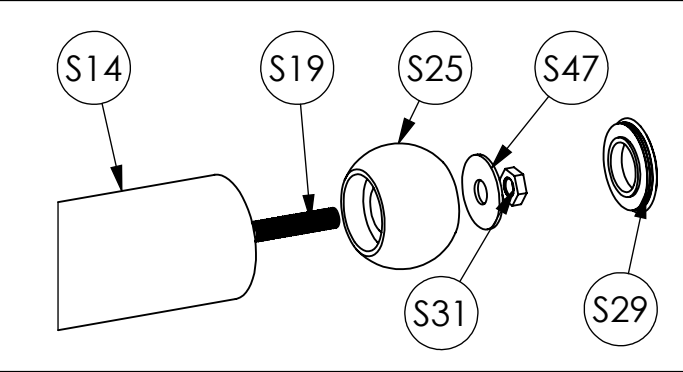
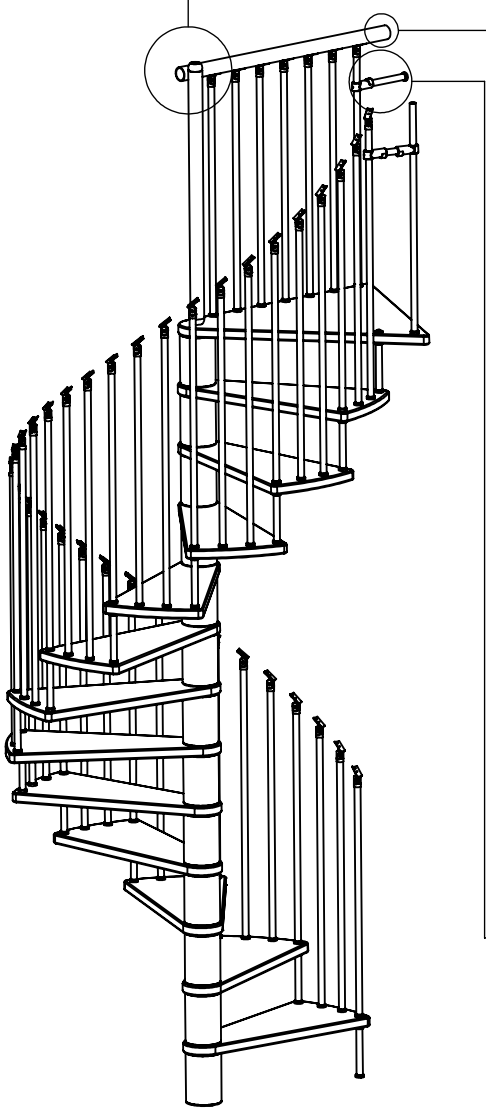
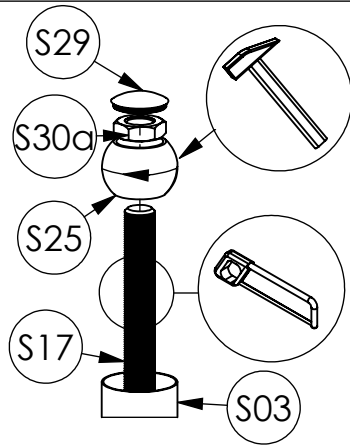
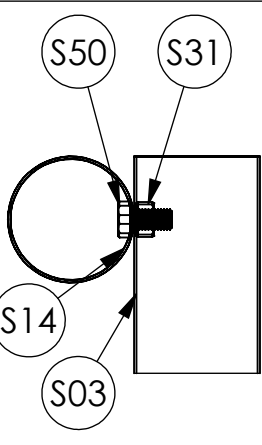
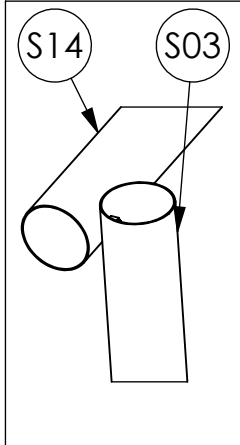
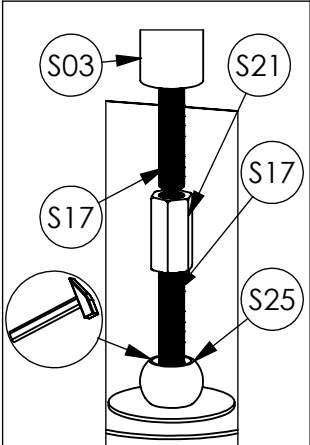

7

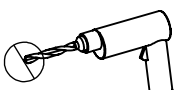
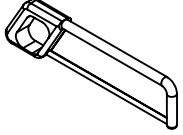
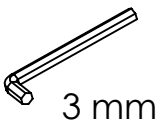
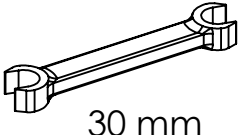

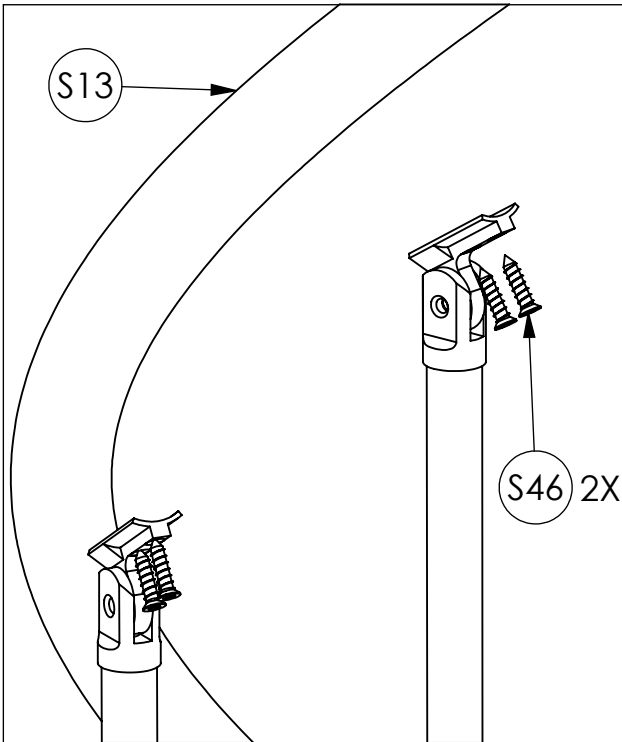
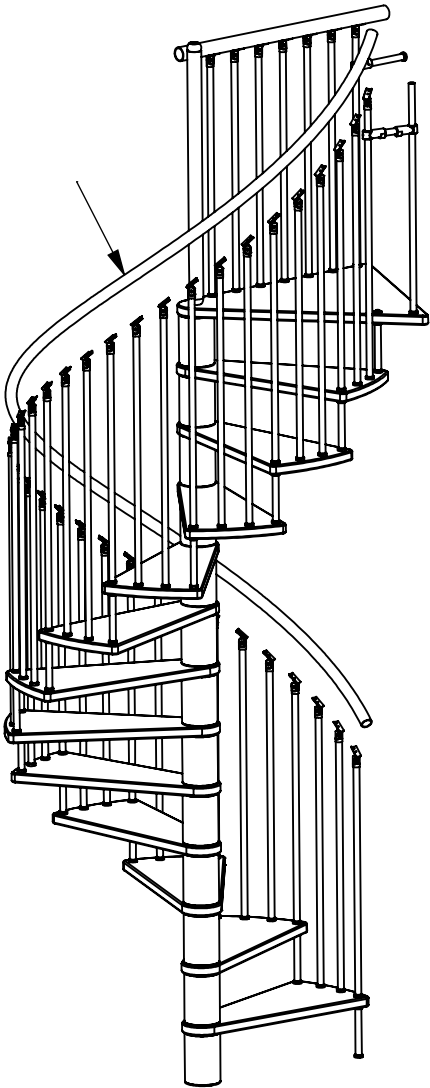
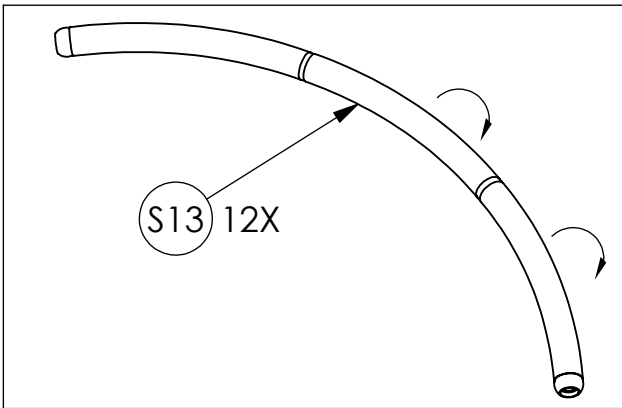
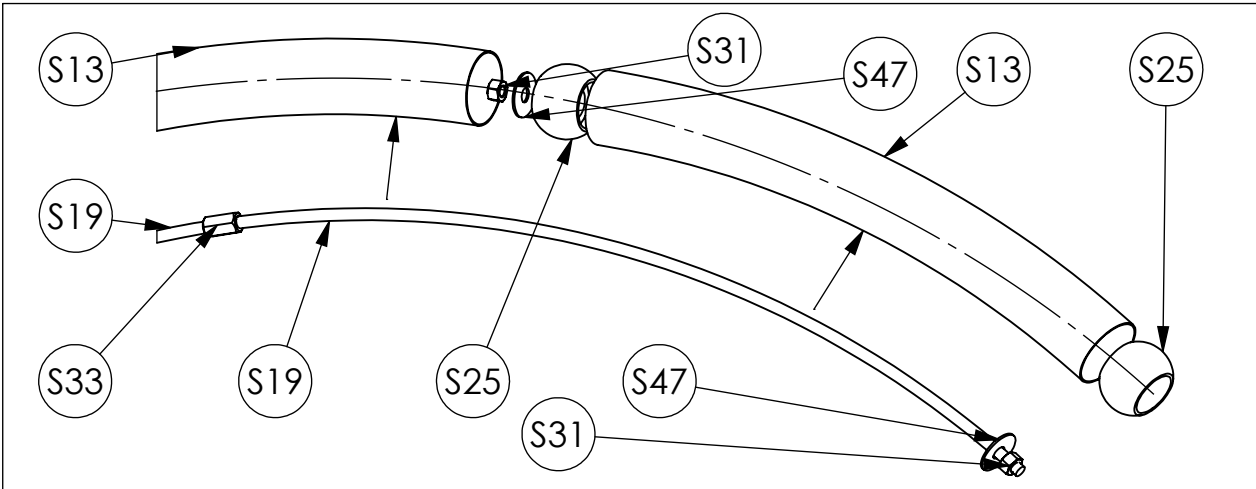

8

