

Facade 1-4

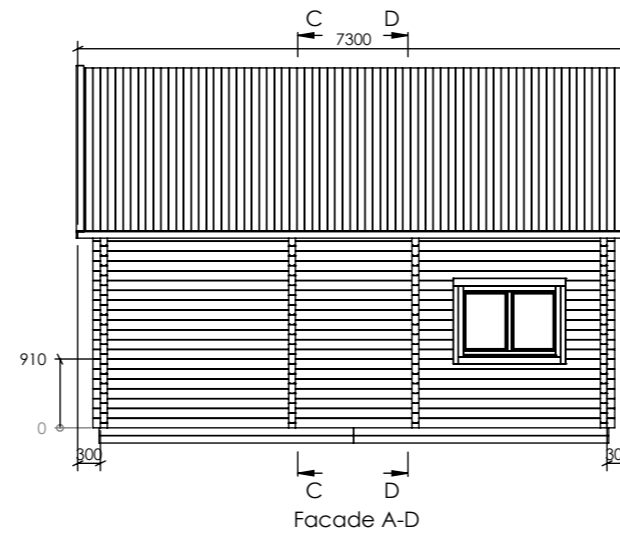

Facade A-D

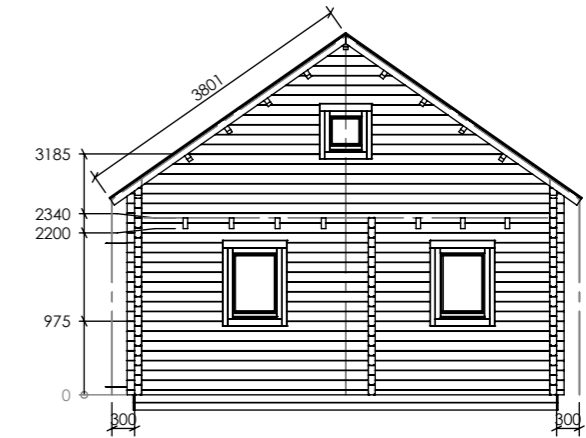

Facade 4-1

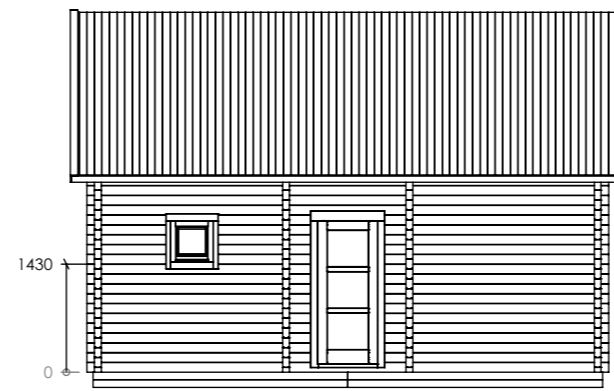

Facade D-A



C-C

ITEM NO.	DESCRIPTION	QTY.
1	Door D52 1980x880	1
2	Door D52 1980x880	2
3	Window L60, 980x1380	3
4	Window L60, 980x740	2
5	Window L60, 580x580	2
6	STAIRS	1

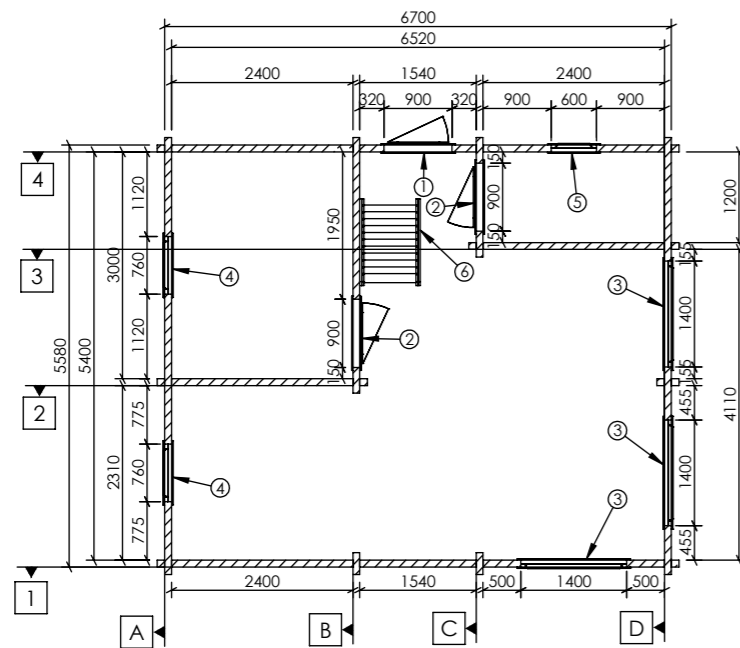

Plan

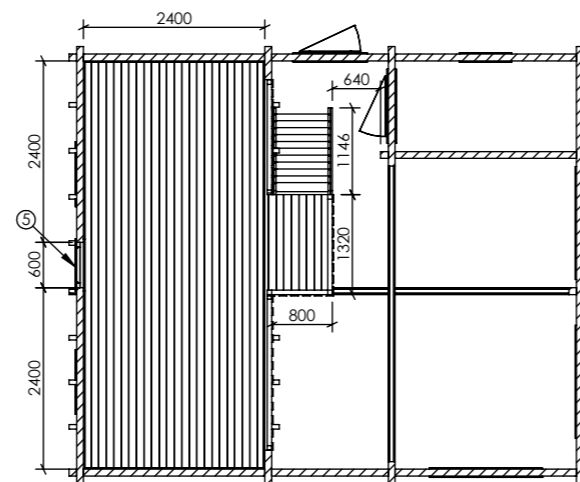

Plan II

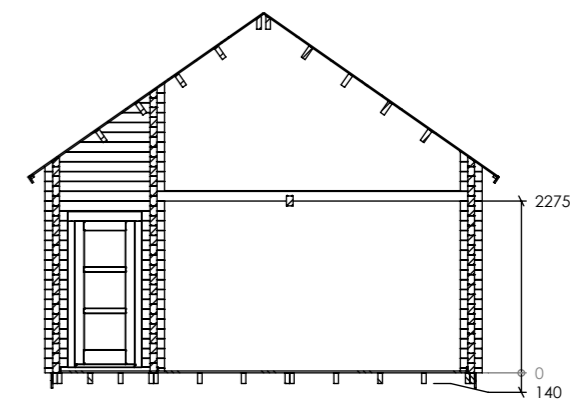

D-D

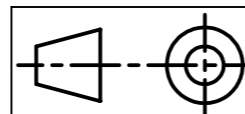

Hannele-Marie NB6754 V.2 (90)

A3 M1:100

Plan/Facades