

Date	2022-10-25

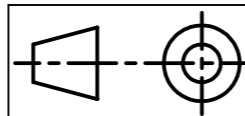

2022-10-25
13:52:00
Date

20269 Bore 36 (44) R. Kazinczy

Sheet1

A3

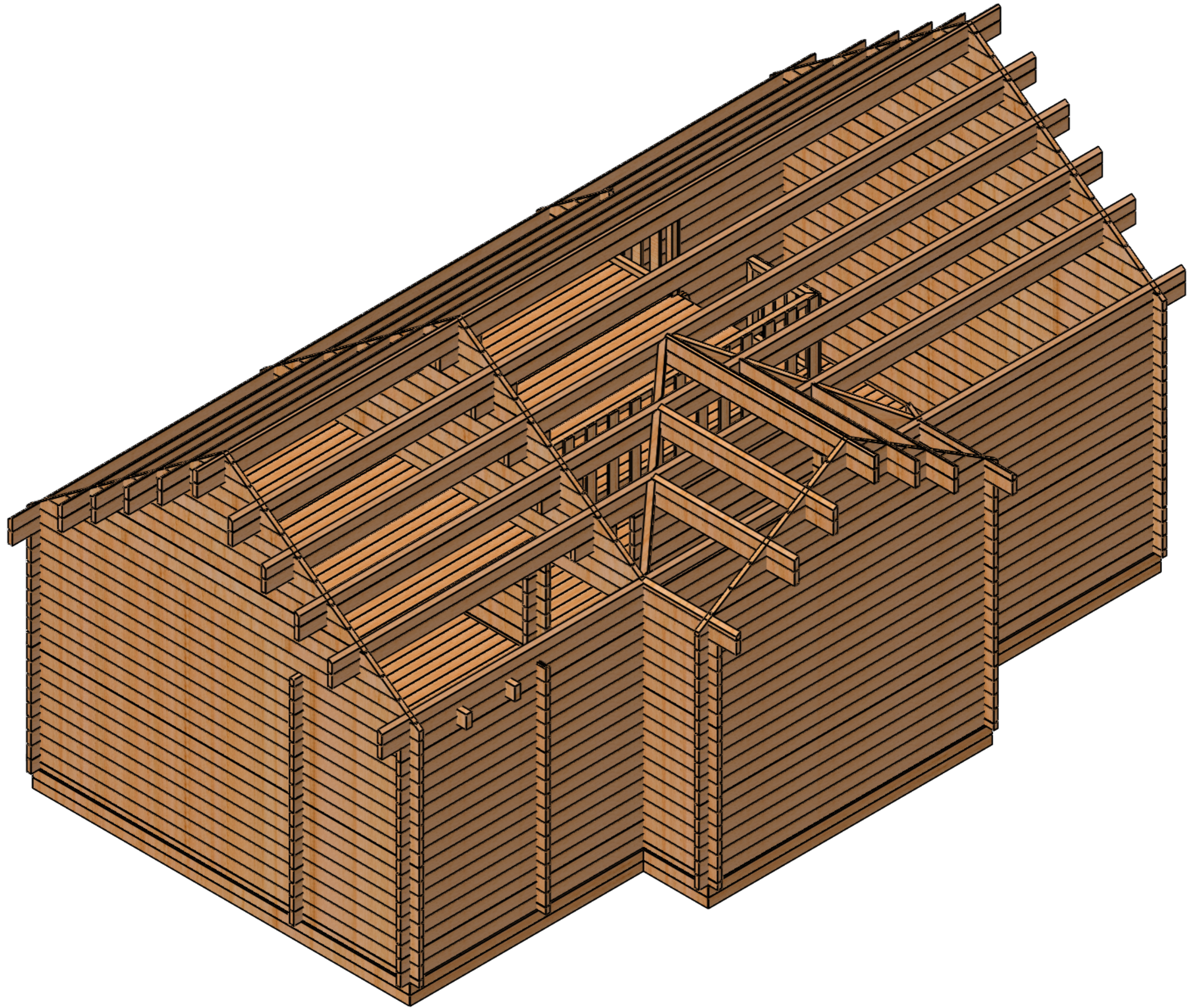

Date	2022-10-25

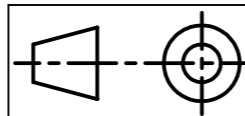

	Sheet 3-3	

2022-10-25 13:52:00
Date

20269 Bore 36 (44) R. Kazinczy

A3
Sheet3

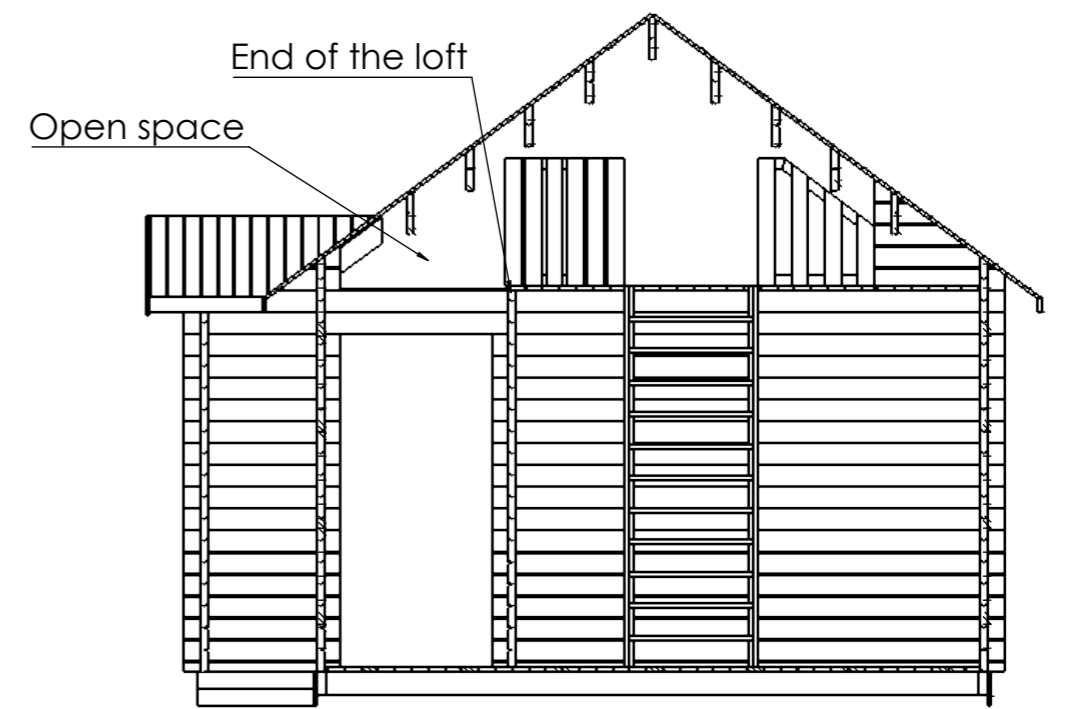
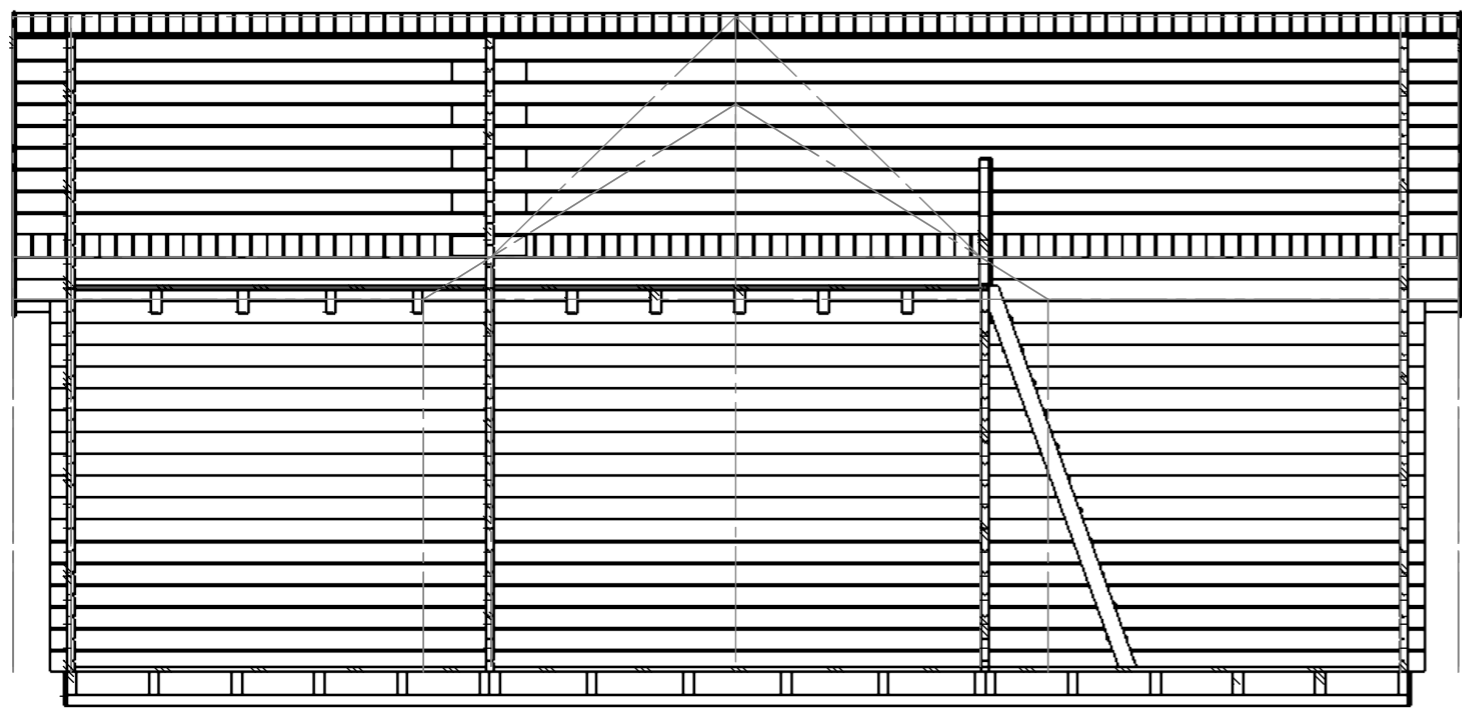
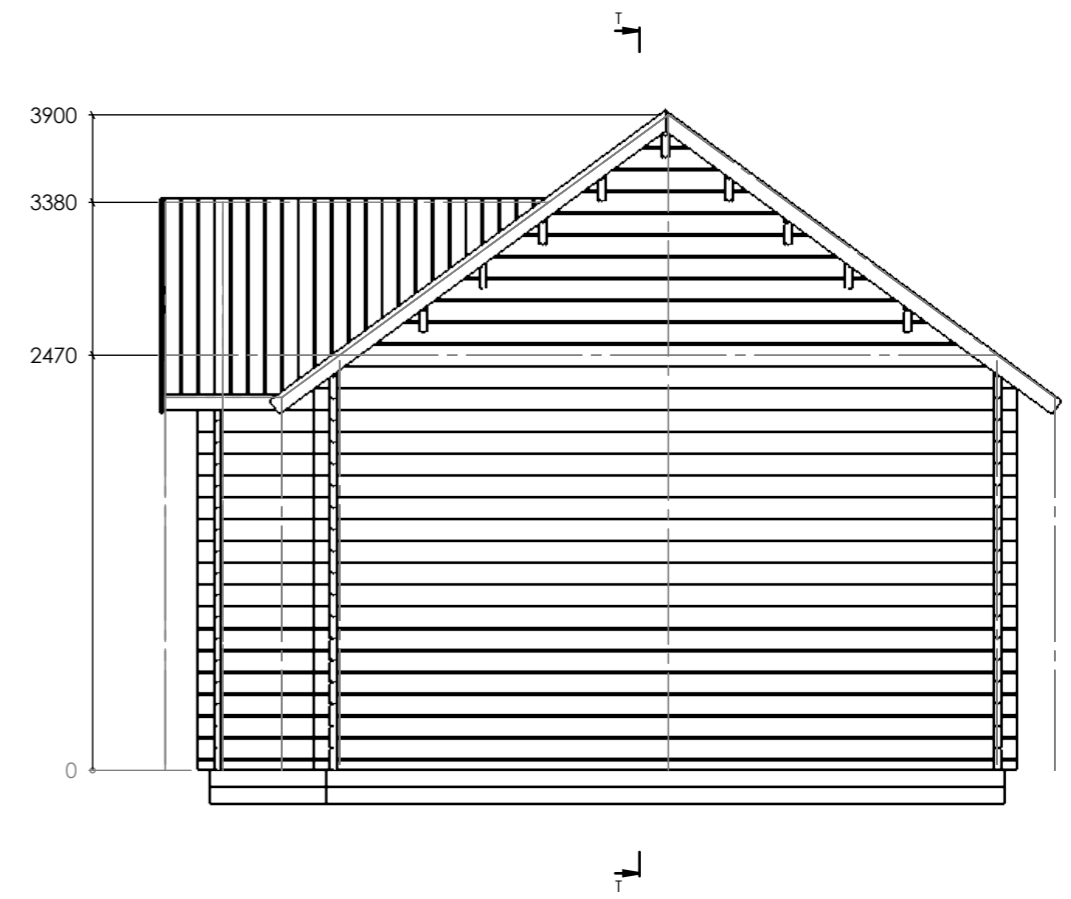
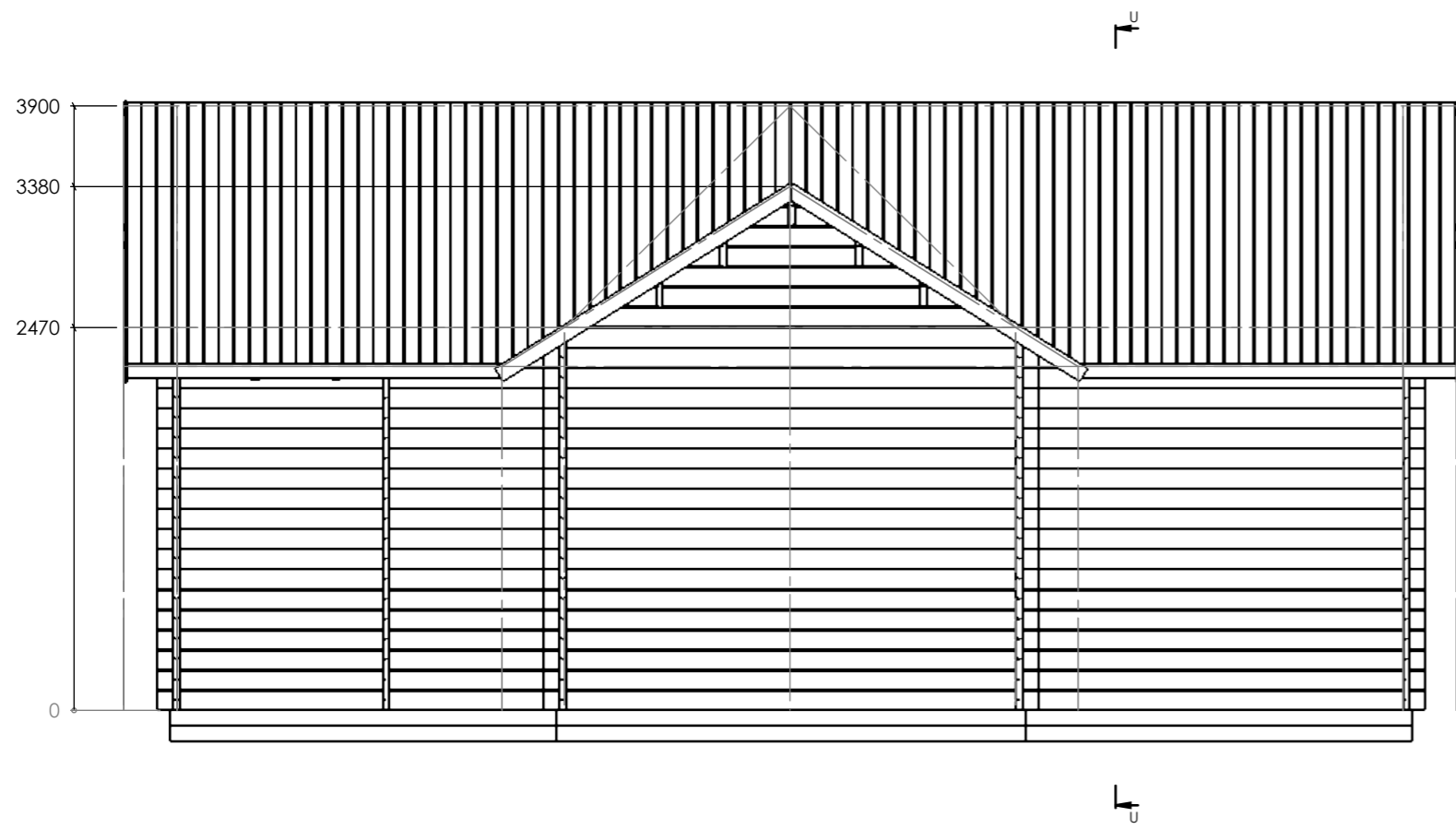

SECTION T-T

SECTION U-U

Date	2022-10-25
------	------------

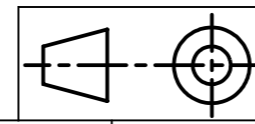

Sheet 2-3	Date	2022-10-25 13:52:00	20269 Bore 36 (44) R. Kazinczy	A3
				Sheet2

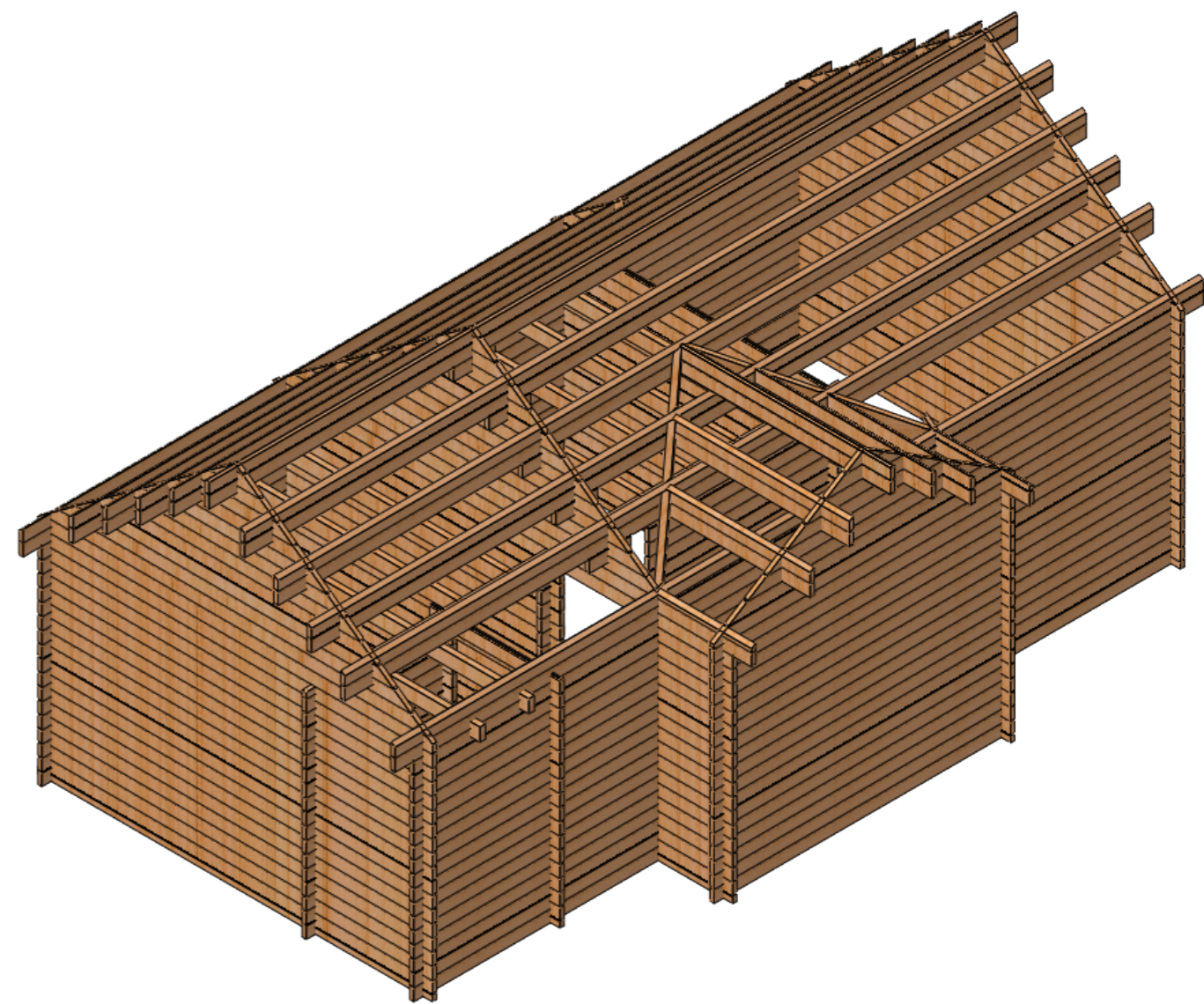
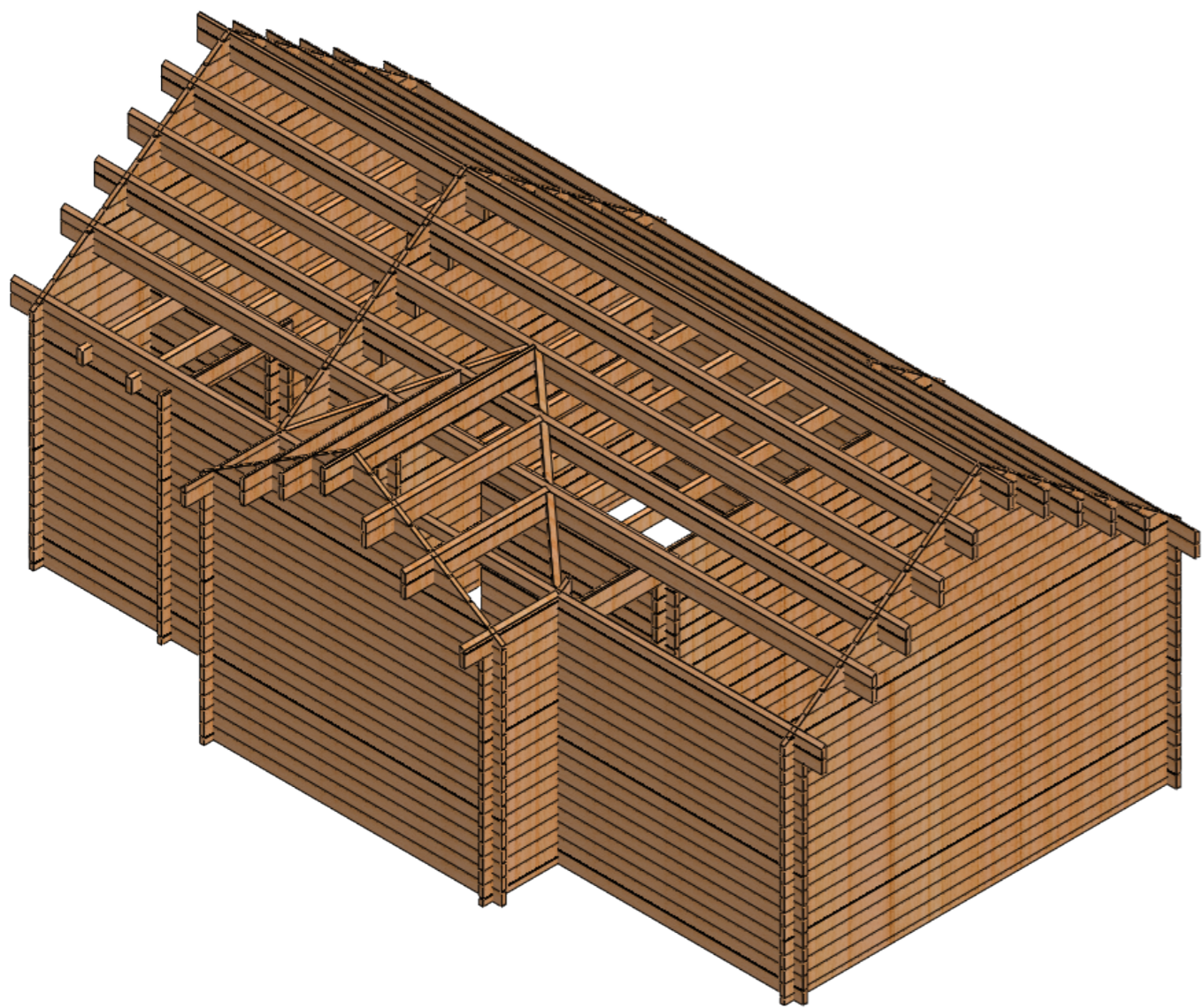

Date	2022-07-18

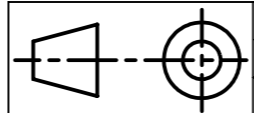

2022-10-10 13:43:55
Date

20269 Bore 36 (44) R. Kazinczy [W]

A3
Sheet2

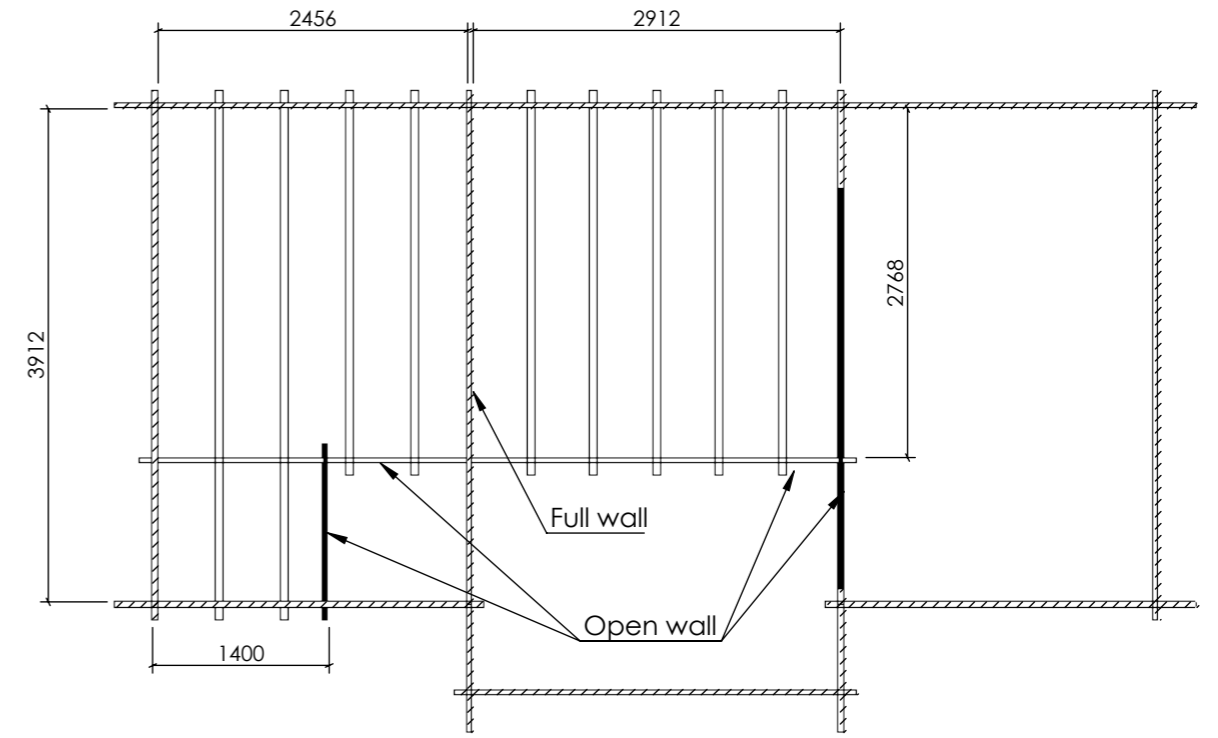
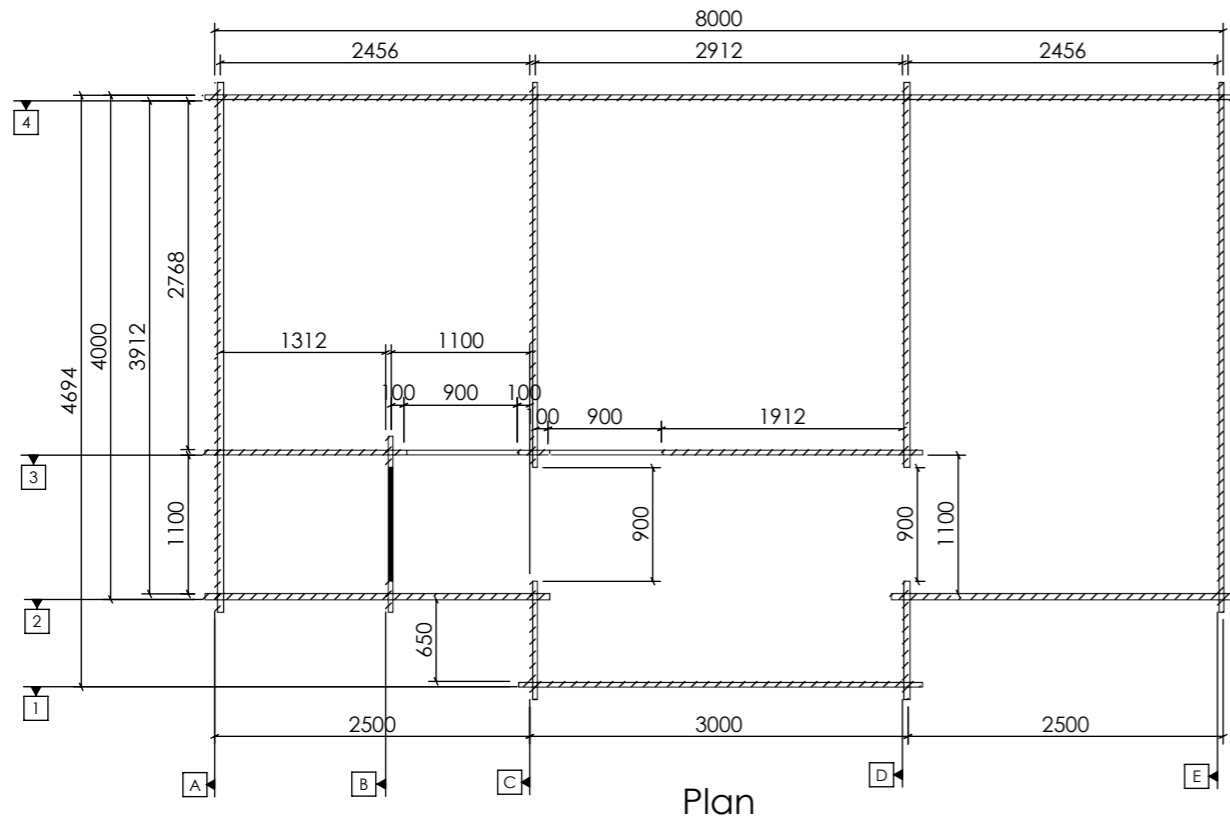
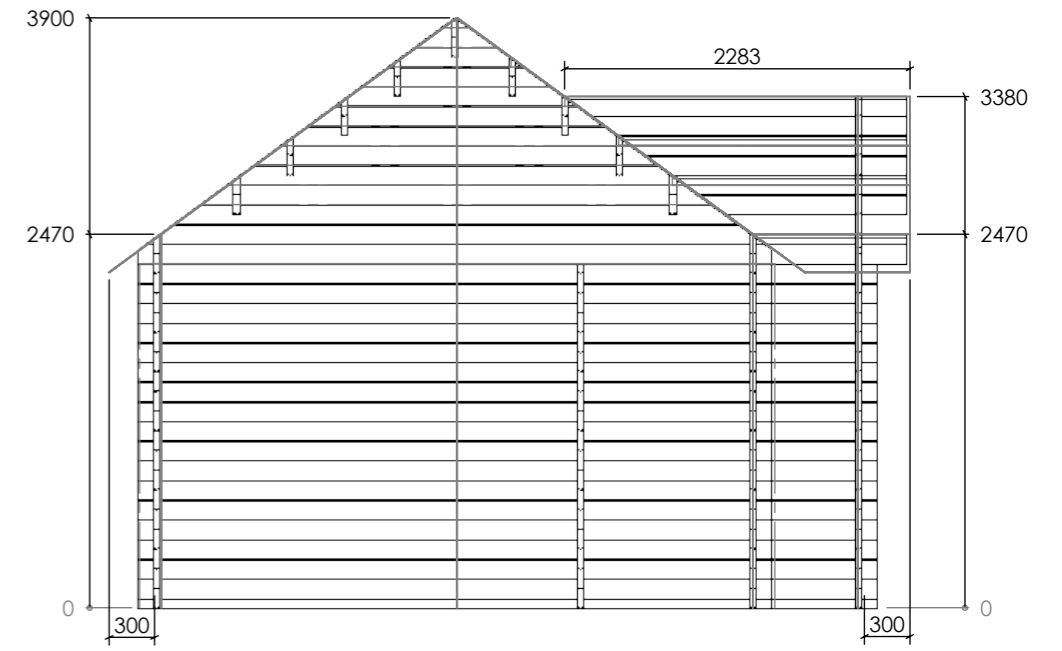
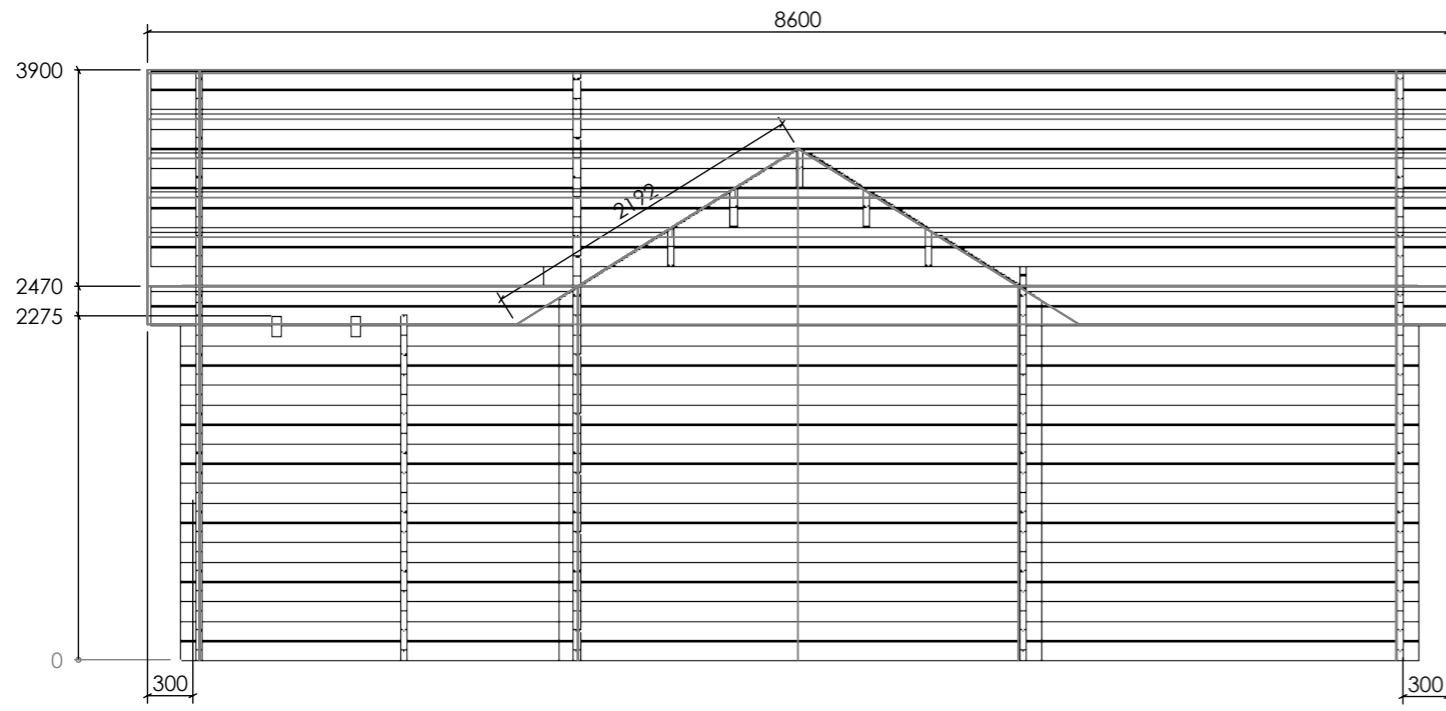

Date	2022-07-18
------	------------

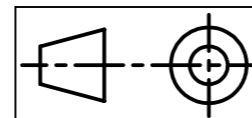

Sheet 2-3

2022-10-10 13:43:55
Date

20269 Bore 36 (44) R. Kazinczy [W]

A3
Sheet1

2

1

T

Tc

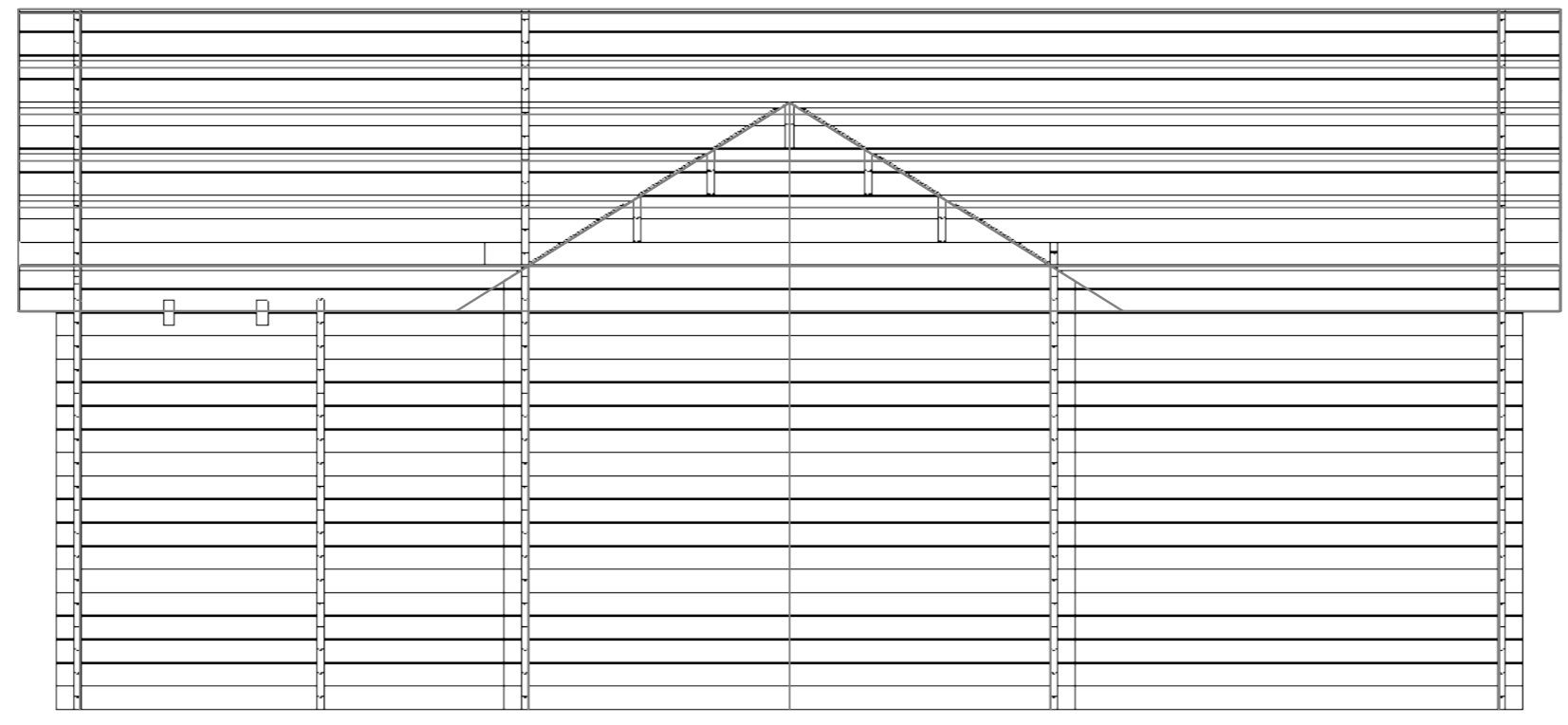

T

Tc

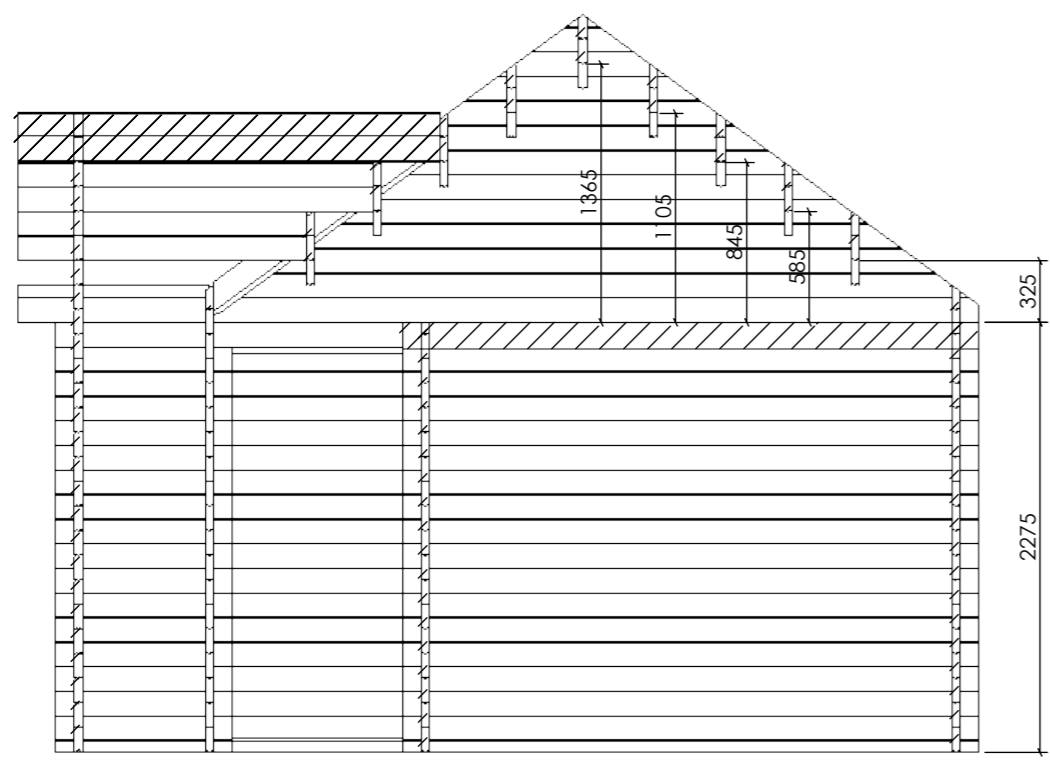

SECTION T-T

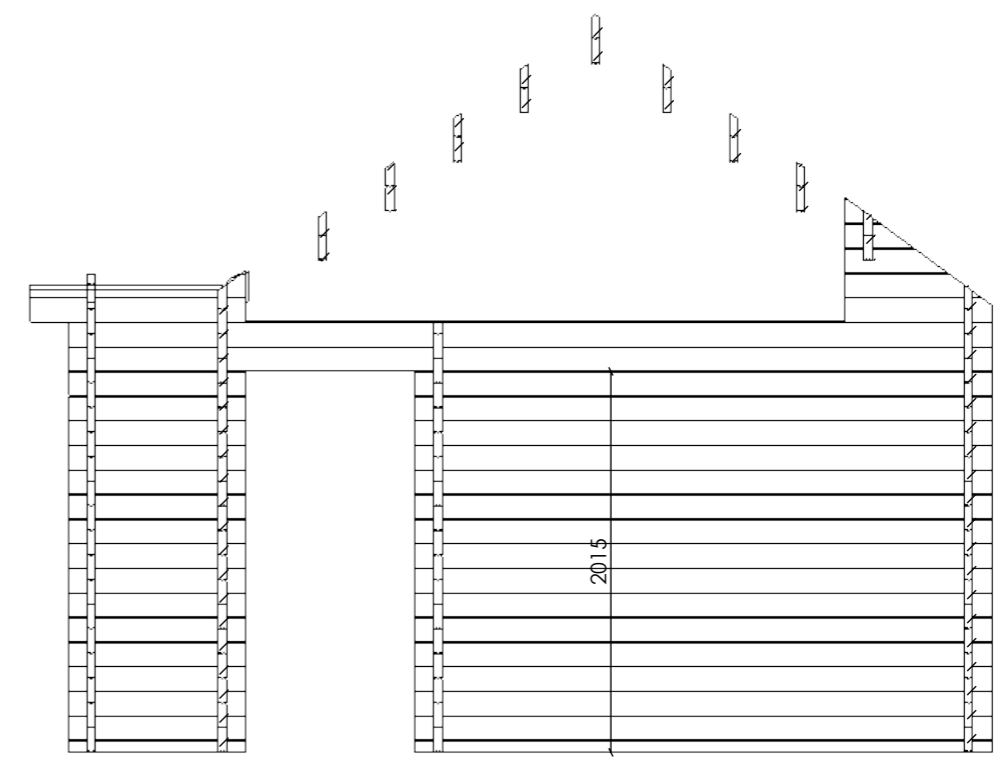

SECTION U-U

Date	2022-07-18
------	------------

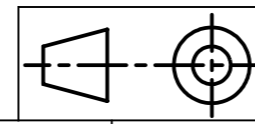

Sheet 3-3	2022-10-10 13:43:55	20269 Bore 36 (44) R. Kazinczy [W]	A3
Date			Sheet3

2

1

A