

# CLASSIC CONTROL

FOR STP and STN STEAM GENERATORS



Congratulations on your purchase of Classic Control Unit!  
Please read the manual carefully before using the steam generator.

# TABLE OF CONTENTS

<b>INTRODUCTION</b> .....	3
<b>INSTALLING THE CONTROL UNIT</b> .....	4
ON/OFF Mode .....	5
Standby Mode.....	5
Autodrain Mode.....	6
Temperature / Timer .....	6
Key Lock.....	6
Changing the values.....	7
Cabin Light / Dimmer .....	7
Fan .....	7
Scent Pump .....	8
Demand Button.....	9
Switching Between Different Modes.....	9
<b>MAINTENANCE</b> .....	10
Decalcification.....	10
<b>TROUBLESHOOTING</b> .....	11
Error codes:.....	11



READ THE MANUAL FOR  
ADDITIONAL IMPORTANT  
INSTRUCTIONS



COVERING THE HEATER  
CAUSES FIRE HAZARD

# INTRODUCTION

There are four different operation modes in the unit: Off, On, Standby and Drain. The user can easily switch between different modes, making the steam bathing more convenient with less energy consumption.

To use steam room the control unit needs to be in the On mode. In the On mode, the steamer is active, the temperature in the steam room will be kept in the preferred, set temperature, with occasional discharge of steam.

However, if the steam room is not used constantly, the generator can be set to Standby mode. The water in the tank is kept warm, with minimal energy usage. The generator is able to produce steam shortly after the unit is switch back to On mode for the convenience of the users. More details about the different modes and how to move between them can be found in the text and graph following.



# INSTALLING THE CONTROL UNIT

SAWO Steam Control sets the temperature of your steam room. Mount the steam control unit on an accessible area outside the steam room. It is recommended not to place the steam control near to showers or similar wet places.

Never attempt to modify or to fix the steam control. Ask your licensed technician or your nearest service centre for repair.

Before installation mains supply of the generator must be switch off from the circuit breaker.

**NOTE!**  
If the control is attached to a concrete wall, provide an interface holder or equivalent to surface mount the control into it.

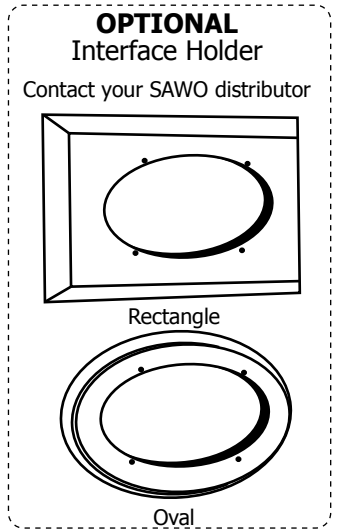
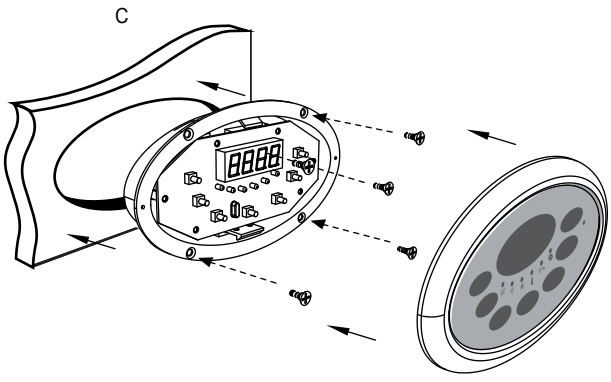
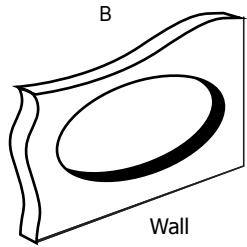
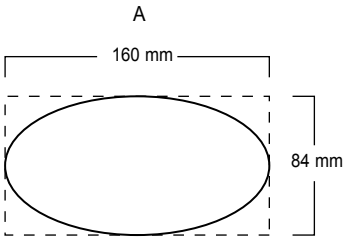

## On/Off Mode



When the power switch is turned "On" the software versions of the control board and the user interface will be displayed for 1 second each. Then the control unit will go to "Off" mode. In the "Off" mode, the display is blank.

The auto drain can be disabled or enabled in the "Off" mode. Press and hold the Up button, then press the Power button. The display will show "Adr off" or "Adr on" as feedback.

## On Mode

For "On" mode press "Power" button.

First, the set steam room temperature is displayed blinking for 5 seconds. Then the user can change the following settings; session time, temperature and fan (not all the models have the same features), by pressing the corresponding button in the control unit. The up and down arrow buttons can be used to increase and decrease the values.

If no buttons are pressed for 10 seconds, the set temperature for the steam room will be displayed.

## Standby Mode



During the standby-mode the water in the steam generator tank is kept hot. This minimizes the time to produce steam when generator goes to on-mode next time.

Standby-mode can be activated by any of the following methods when the unit is in on-mode:

1. Short press "Standby" button
2. Short press "Power" button
3. When session time expires.

In standby-mode text "Standby" is displayed altering with the remaining standby time. To change remaining time press "up" or "down" arrow buttons. If the time is changed during the first 5 minutes after the activation of standby-mode, the time will be saved as a new default standby time.

To activate on-mode again short press the "standby" button.

To go off-mode:

1. Press "Power" button for more than 3 seconds.
2. Press "Standby" button for more than 3 seconds to activate autodrain process, after which the unit goes automatically off-mode. (If autodrain feature is not available the unit will go off-mode)
3. Wait until remaining standby time expires and autodrain process (if available) completes.

## Auto drain Mode

The auto drain feature automatically drains the water system after every use. The tank is flushed and will remain empty until the steam generator is used again.

After the Standby time runs out, control unit automatically goes to Autodrain mode. When the drain cycle is activated, the generator's tank will be filled first. The water inside the tank will be cooled down, so the valve can be opened, as the water is not boiling hot anymore.

The draining process will take about 10 minutes.

User can cancel auto drain process whenever the water level in the tank is at normal or below normal level by pressing "power" button for more than 3 seconds. To start Auto Drain in "On" mode press "Power" or "Standby" button followed by a long press (more than 3 seconds) of "Standby" button.

## Temperature / Timer



The temperature/timer button can be used to switch between the temperature and session time.

When the steam generator is switched on, the set temperature at the steam room is displayed. It can be changed by pressing up and down buttons.

If the temperature/timer button is pressed, the remaining session time will be displayed. It can be changed by pressing up and down buttons. The session time will be saved as the default session time if it was changed within the first 5 mins from the beginning of "On" mode.

If the temperature/timer button is pressed again, the unit will return displaying the set temperature. In addition, if no buttons are pressed for 10 seconds, the set temperature of the steam room will be displayed.

## Key Lock



Lock and unlock the key pad by pressing the up and down buttons at the same time for more than 5 seconds. A high beep will confirm the activation and the deactivation.

Only On/Off, Standby and Cabin light buttons are usable when the key pad is locked. If other buttons are pressed, "----" is shown in the display.

The key lock function is set automatically if it was left active during the previous operation.

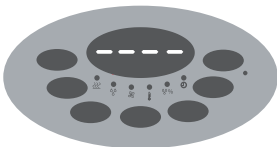

## Changing the values



Pressing the up or down button in the settings menu will in- or decrease the currently displayed value. A value cannot be in- or decreased above or below its maximum or minimum value, if it is tried low tone buzzer alarms the user.

The up and down buttons are repetitive. Holding the up or down button will cause the value to in- or decrease with an increased rate.

If no keys are pressed within 5 seconds, changes in the values are confirmed.

In the "On" mode, if no keys are pressed for 10 seconds, the display will automatically display the set temperature.

## Optional Features

(Optional features are not available in every model)

### Cabin Light / Dimmer



If the dimmer is not present and the cabin light button is pressed, it will switch the cabin light On/Off. When cabin light is ON red LED-indicator next to Cabin light button in the panel is lit.

If dimmer feature is available press "cabin light" button to turn cabin lights on and off. Light intensity value will be shown in the display and by pressing "up" or "down" arrows cabin light can be brighten or dimmed respectively.

If cabin lights are already turned on long press "cabin light" button to activate dimmer in order to change light intensity.

If no buttons are pressed within 5 seconds the last cabin light intensity value will be saved.

### Fan



Fan can be operated in "On" and "Standby" modes. Long press (more than 3 seconds) "Fan/Scnt" button in order to switch fan on/off.

## Scent Pump



Before switching scent pump on make sure there is enough aroma in the aroma container. Never run the scent pump dry.

Scent pump can be operated in "On" mode only. In order to switch scent pump on/off short press "Fan/Scent" button. The Scent pump is allowed to be turned on only when the water in the tank is boiling.

Each time the scent pump is switched on the interval of the scent pump functioning is displayed. Interval can now be changed by pressing "up" or "down" arrow buttons between 1 (scent pump is activated every 20 mins) and 20 (pump on continuously). If no keys are pressed within 5 seconds, the previously displayed value will be shown again and the scent pump setting is saved.

If scent pump is on when the session time expires or the steam generator is turned off by pressing "power" button, scent pump will turn off too. Scent pump "on" and "interval" settings are saved and pump starts automatically on the next session.

To switch off the scent pump short press "Fan/Scent" button in "On" mode.

When the aroma oil is changed, check that the pipeline is not broken or it does not leak. It is also recommended to wash the fragrance container between changes, especially when using different fragrances.

The pump is easy to refill quickly: short press "Fan/Scent" button in "On" mode to activate interval value display. Press and hold "Up" arrow button to reach max. value 20 and scent pump will run continuously. It will take about 10 seconds for every 1 meter of pipeline for aroma liquid to reach the pump. As soon as the aroma liquid has reach the pump reset the pump functioning interval as preferred.

Use only fragrances meant for steam generator use. Follow the instructions in the fragrance packing.



## Demand Button



A separate demand button can be installed on any desired location including inside the steam room. Press of the demand button will immediately release extra steam for 30 seconds.

Pressing the "Demand" button when the steam generator is in "Off" or Standby" mode will switch the control unit to "On" mode.

## Switching Between Different Modes

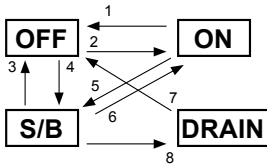

1. Press On/Off button for more than 3 seconds.
2. Press On/Off button or demand button.
3. Press On/Off button for more than 3 seconds.
4. Press Standby button.
5. Press On/Off button or Standby button or when the session time expires.
6. Press On/Off button or Standby button or demand button.
7. Press On/Off button for more than 3 seconds or when the drain time expires.
8. Press Standby button for more than 3 seconds or when the session time expires.

# MAINTENANCE

## Decalcification

Tap water contains impurities, for example lime, that can cause calcium deposit and block the internal parts of the steam generator. To prevent this and prolong the lifetime of steam generator it is recommended to have a water filter and water softener. They are connected to the water source of the steam generator's water inlet.

SAWO Decalcifying Solution can be used for decalcification. Follow these guidelines to perform preventative maintenance of the steam generator.



### WARNING!

Never add the Decalcifying Solution when the generator is on, it can cause serious burns!

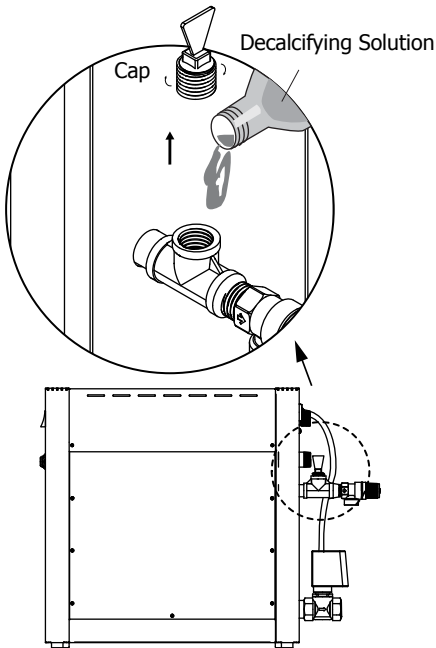

### STP Classic Control:

1. Make sure that steam generator is OFF. Remove the cap of tee pipe in the over pressure valve piping. Pour the decalcifying solution into the tank. Return back the cap to its original position when done.
2. Turn ON the steam generator and wait until water inside the tank starts to boil. Let the solution boil for 5 minutes.
  - 3.1 If standby mode is available:  
Press shortly Standby button. Steam generator goes to standby mode and after time expires, water will be drained automatically. After draining screen goes to OFF state.
  - 3.2 If standby mode is not available:  
Turn OFF the steam generator. Let the solution stay in the tank 30 minutes and then drain manually by pulling lever down.
4. Fill and drain the tank with water two times more by switching ON and draining the steam generator.

Use Decalcifying Solution as follows:

Steam Generator (kW)	Decalcifying Solution (ml)
3-7,5	250
9-15	500

For steam generators in commercial use (over 5 hours continuously daily) additional service plan is recommended twice a year. Please contact your service center for details.

### Frequency for decalcification:

Unit dH where 1 dH is 10 mg calcium in 1 liter of water

< 3 °dH = very soft water, decalcification every 500 operation hours

3-6 °dH = soft water, decalcification every 100 operation hours

6-9 °dH = hard water, decalcification every 50 operation hours

9-18 °dH = very hard water, decalcification every 30 operation hours

# TROUBLESHOOTING

If an error occurs, the steam generator will be switched off. There will be a warning beep to alarm the user every 2 seconds. The code for the error will be displayed blinking in the control panel, see the table below.

Please note, only a qualified electrician or maintenance personnel are allowed to make the service operations and repairs!

If an error occurs in one of the slave units, error message is followed by slave number. For example: E1 -> S2 -> E1 ->S2... Pressing ON/OFF button disables the slave and rest of the generators can operate normally.

Possible errors are:

Code	Problem	Solution
E1	Temperature sensor 1 not connected.	Check the wire between the sensor and the control unit.
E2	Temperature sensor 1 short circuit.	If there is no problem with the wires and they are correctly installed, check the sensor.
E3	Temperature sensor 2 not connected.	If no problem can be found, contact the retailer.
E4	Temperature sensor 2 short circuit.	
E5	Temperature fuse defect.	Check the wire between the fuse and the control unit. Fuse has probably overheated. The reason for it needs to be discovered before using the steam generator again. A new fuse is needed.  If no problem can be found, contact the retailer.

Code	Problem	Solution
E6	Water level too high and operation not permitted.	Check that the drain valve is not blocked. Clean the level probes. If no problem can be found, contact the retailer.
E7	Water level too low and operation not permitted.	Check that water supply is open and there is enough pressure. Check solenoid valve. Clean level probes. If no problem can be found, contact the retailer.
E8	Illogical combination of water level measurements.	Clean level probes. If no problem can be found, contact the retailer.
E9	Fill failure.	Check that water supply is open and there is enough pressure. Check solenoid valve. Clean level probes. If no problem can be found, contact the retailer.
E10	Drain failure.	Check that the drain valve is connected and not blocked. Clean the level probes. If no problem can be found, contact the retailer.
E11	Communication failure.	Check the RJ12 cable. If the area where cable is located has many other cables, it can cause EMC problems. If no problem can be found, contact the retailer.
E12	Temperature is greater than the maximum temperature.	Contact qualified electrician or maintenance personnel before using the steam generator again.
E13	No master steam generator connected.	Dip switch setting is incorrect. Check dip switch settings. Check RJ12 for loose contact. Replace RJ12. If no problem can be found, contact the retailer.

CE IPX 4 

Subject to change without notice.



[www.sawo.com](http://www.sawo.com) | [info@sawo.com](mailto:info@sawo.com)

STN\_Classic\_ML\_(En0718)