

STAINLESS STEEL SHOWERS HOT AND COLD WATER

USER AND MAINTENANCE MANUAL



SHOWERS SERIES ALGERO

SINED, Outdoor shower in sawn stainless steel with practical hand shower. Elegance and hot and cold water all year round in the garden.

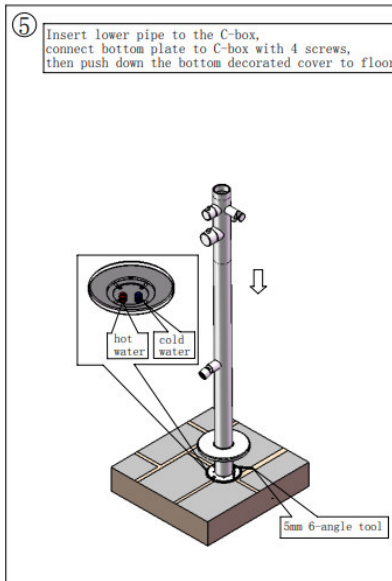
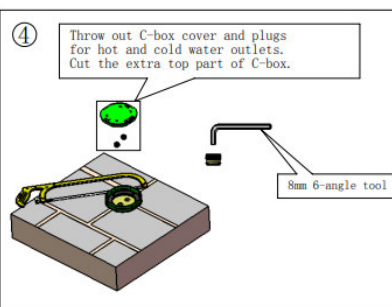
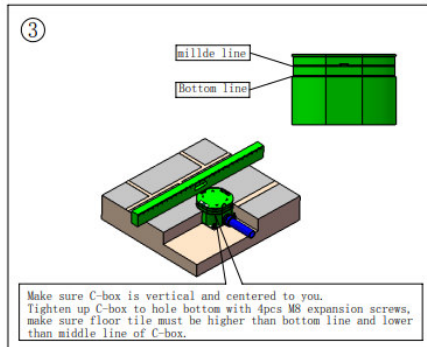
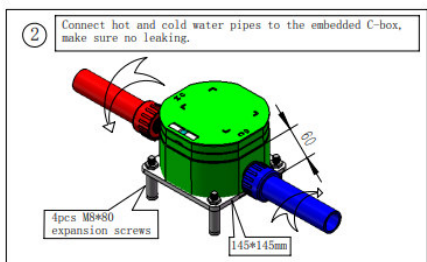
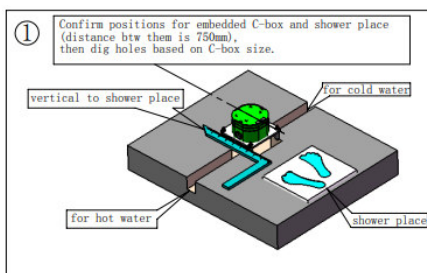

Outdoor Shower simple installation manual for Hot and Cold Water with embedded C-box

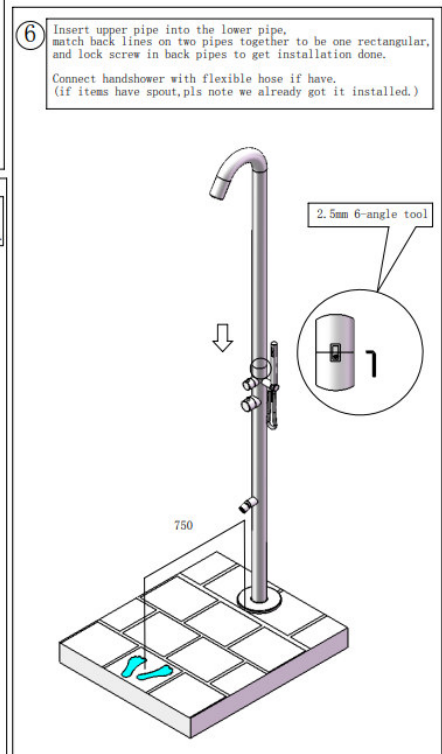

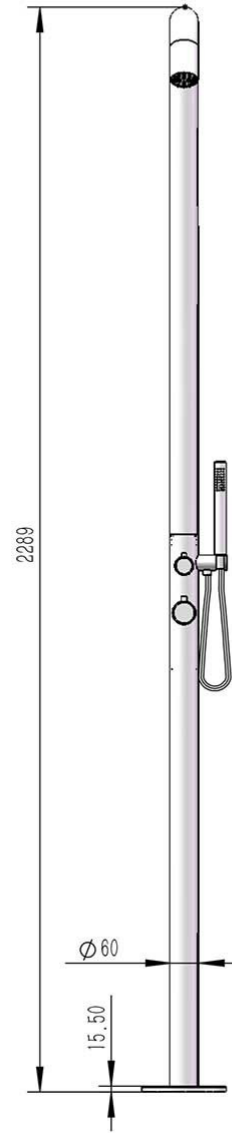
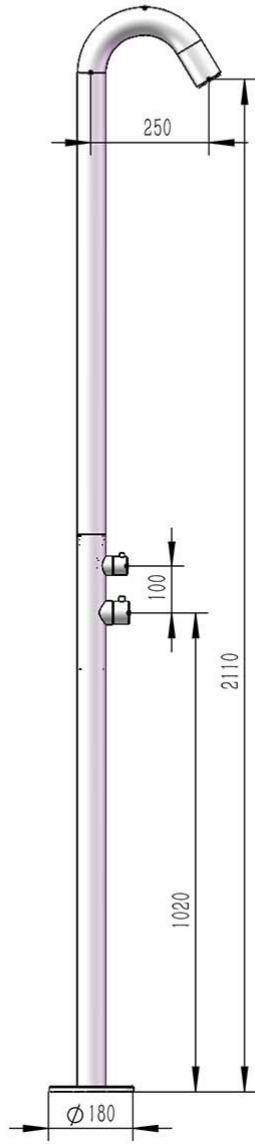

WARNINGS

Please read the instructions carefully before installing and using the shower.

This manual contains important information for the proper use and maintenance of your shower and should be kept for future reference.

Content

The package contains

- Shower with mixer and overhead shower as well as additional accessories (e.g. foot wash basin, hand shower, etc.) depending on the model purchased
- Installation kit complete with screws
- Use and Maintenance Manual

1) Installation

The installation must be carried out by specialized personnel on a solid support, perfectly flat and level, able to support the weight of the shower and prevent it from falling.

The installation procedure is explained in detail in the attached sheet which is an integral part of this manual.

2) Use

Showers are particularly sensitive to impurities and limescale and, if installed outdoors, to low temperatures during the winter period.

- It is recommended to purge the system before connecting the water pipes to prevent dirt and impurities from getting into the shower and causing malfunctions.
- To avoid the formation of limescale, it is strongly recommended to install a special filter at the water inlet and to periodically clean the shower, the nozzles and the shower head.
- Before the winter period or in case of prolonged non-use, it is recommended to close the water supply and empty the shower completely.

It is also advisable to dismantle the shower and store it during the winter period or to protect it with suitable covers.

3) Cleaning

- To prevent limescale stains from forming on the outside of the shower, simply clean it with a damp cloth and soap, rinse it and dry it.
- Do not use aggressive or abrasive cleaners or those containing alcohol, hydrochloric acid or phosphoric acid.

4) Warranty

SINED showers have a 2-year warranty from the date of purchase against defects in materials and workmanship.

- The warranty does not cover components subject to wear and tear, including mixers, shower heads, taps, etc.

- The warranty does not cover damage due to incorrect assembly, improper use and incorrect maintenance (e.g. use of inappropriate cleaning agents).
- Damage resulting from the use of non-original spare parts is not covered by the warranty.
- The warranty does not cover any damage resulting from work not carried out by specialised technicians.
- Damage due to frost, limescale or other impurities inside the shower is not covered by the warranty.

In the presence of problems covered by the warranty, the product must be returned to the seller.

- The product must be carefully packed and complete with all its parts and accessories;
- The reason for the return must be described in detail and proof of purchase (invoice or receipt) must be provided;
- Return shipping costs are the responsibility of the buyer;
- The returned product will be checked by the seller and repaired or replaced at the sole discretion of the seller.

Production: M8 IMP & EXP CO., LTD.
Address: No 5, Longxi Industrial Area
Yuhuan, Zhejiang, CHINA

Made in China Imported in Italy by M.P.C. srl Via Tortona 21 Milano 20144 Italy Tel +39 0221117815 e-mail info@mpcshop.it website www.sinedtechnology.com

The trademark SINED and the logo SINED are registered by SINED VENTAS ONLINE S.L.U. EUTM 018196373